



**Solaris 150 Rapid Thermal Processing system**

**Installation Manual**

**Document #82007-0001 Rev. Q  
For Software Revision 3.6**

## SERVICE INFORMATION

Customer technical support is available from Surface Science Integration to provide information not included in this manual. The Customer Support Department is open Monday through Friday, 8:00 a.m. to 5:00 p.m., Pacific Time. A paging system is available for technical support at all other hours. Have your model number, serial number, and your phone number ready to leave on the recording, and a customer support engineer will return your call. Field service support and parts are available from Surface Science Integration. The office is open Monday through Friday, 8:00 a.m. to 6:00 p.m., Pacific Time. At other hours, an operator will take messages from any customers with a tool still under a warranty contract.

### **Surface Science Integration—Customer Support Department**

Phone: (800) 749-7473 ext 102

Fax: (800) 749-7473

For parts and online technical support:

[www.ssintegration.com](http://www.ssintegration.com)

email: [sales@ssintegration.com](mailto:sales@ssintegration.com)

**Disclaimer:** Surface Science Integration makes no representations or warranties with respect to this manual, except as outlined in the product warranty. Further, Surface Science Integration reserves the right to make changes in the specifications of the product described within this manual at any time without notice and without obligation.

## WARRANTY

Surface Science Integration expressly warrants that it will either repair or replace on the terms described below any product or component which, within twelve (12) months from the date of shipment (three [3] years with respect to tungsten halogen lamps), proves to be defective in design, material or workmanship in the course of its normal intended use. The customer shall promptly provide Surface Science Integration details of any product or component thought to be defective and request a Return Material Authorization (RMA). Within thirty (30) days after receipt of the RMA number from **SSI**, the customer shall return the defective product or component **SSI** freight paid. Part(s) not returned to Surface Science Integration (when a replacement part was first sent to customer with expectation that the customer would return old part on RMA) is (are) subject to charge (billable) at current price. As soon as is practicable after issue of the RMA, Surface Science Integration shall repair/replace and return any product/component found to be defective. Repair/replaced and returned products and components shall be warranted as above for the duration of the warranty period of the defective product, and shall be comprised of new or reworked components. Returned product not subject to warranty shall be disposed of at customer's cost and subject to customer's instructions.

Items not covered under the warranty include, but are not limited to:

- Quartzware
- Consumable parts, such as O-Rings, gaskets, fuses, etc.
- Labor to perform routine maintenance and calibration of the system

Surface Science Integration' products are normally intended to be used in a semiconductor processing environment in accordance with the functional, environmental and operational standards published by Surface Science Integration or generally accepted in the industry. Surface Science Integration shall have no warranty obligation with respect to any product that has been modified or altered or with respect to data contained in any product returned to Surface Science Integration by the customer.

Surface Science Integration liability to the customer or anyone claiming through or on the Behalf of customer with respect to any claim or loss arising out of the purchase and/or sale of any Surface Science Integration product or alleged to have resulted from an act or omission of Surface Science Integration shall for no purpose exceed the purchase price of the products with respect to which such liability is claimed. In no event shall Surface Science Integration be liable for consequential damages, losses, expenses or procurement costs arising out of the purchase and/or sale of any Surface Science Integration product, and an action to recover the purchase or to compel such replacement or adjustment shall be customer's sole remedy under the Uniform Commercial Code or otherwise. Ninety (90) days after customer's discovery or receipt of notice thereof shall be deemed a reasonable period within which customer must inform Surface Science Integration of any claim or thereafter be barred from commencing any action on such claim. All claims by, through, or on behalf of customer or others arising out of this transaction shall expire and be forever barred as against Surface Science Integration

unless an action is commenced thereon in a court of competent jurisdiction against Surface Science Integration within one year after claimant's discovery thereof. THE FOREGOING IS SURFACE SCIENCE INTEGRATION SOLE WARRANTY WITH RESPECT TO ITS PRODUCTS AND COMPONENTS. SURFACE SCIENCE INTEGRATION MAKES NO OTHER WARRANTY OF ANY KIND WHATSOEVER, EXPRESS OR IMPLIED. ALL IMPLIED WARRANTIES OF MERCHANTABILITY AND/OR FITNESS FOR A PARTICULAR PURPOSE ARE HEREBY DISCLAIMED BY SURFACE SCIENCE INTEGRATION AND EXCLUDED.

## PREFACE

### INTENDED AUDIENCE

The Solaris 150 Rapid Thermal Processing Systems have been designed to be customer-installed. This installation manual has been written to assist Fabrication Maintenance Engineers in the installation of a Solaris 150 Rapid Thermal Processing System (Solaris 150). Building Planners may also use this document to plan facilities for the system. This manual covers hardware and software installation instructions for SOLARIS S/W

### MANUAL USE

Since the purpose of this manual is to assist with installing a Solaris 150 Rapid Thermal Processing System, all personnel involved in the installation should read the entire manual.

### CONTENT DESCRIPTION

**Section 1** This section is an overview of the installation process for the system. It describes what must be done to prepare for the installation and what tools are required to perform the installation.

**Section 2** This section describes the procedures for unpacking and inspecting the system.

**Section 3** This section describes the installation site requirements, including the dimensions of the system and electrical connections, as well as gas, tube cooling and water specifications and connections.

**Section 4** This section offers recommendations for connecting the utilities to the system which will simplify and minimize service and troubleshooting procedures.

**Section 5** This section describes the quartzware installation process for the quartz tube and tray.

**Section 6** This section describes how to configure and install the computer system. It includes detailed information on loading the SOLARIS S/W software onto the computer.

**Section 7** This section describes the procedures required to power-up the system and the tests which must be performed to ensure safe operation. These tests include the manual tests, computer communications test and temperature control test.

**Section 8** A troubleshooting guide is provided in Section 8, which suggests practical

recommendations for common problems, which may occur during installation. Several types of problems are described: leaks, computer problems, heating chamber problems and chiller problems.

**Appendix A** This appendix contains a list of system specifications.

**Appendix B** This appendix contains a list of recommended spare parts contained in the Level 1, Level 2 and Level 3 spare parts kits.

**Appendix C** This appendix contains information on how to order and return equipment. It also contains information on Service Contracts and Service and Maintenance Training Courses.

### **MANUAL CONVENTIONS**

Notes, cautions and warnings are located in appropriate areas in this manual. • **Notes** provide additional important information which requires special attention.

#### **CAUTION !**

- **Cautions** alert you to avoid system damage.

#### **WARNING !**

- **Warnings** are given for personnel safety to prevent bodily harm.

### **MANUAL REVISION HISTORY**

The Solaris 150 Installation Manual has been assigned assigned part number 82007-0003.

The last four characters (xxxx) identify the version of the manual.

The manual describes the installation of the Solaris 150 with Solaris S/W software .

## **Solaris Safety Features**

This equipment has been designed to provide a safe means of processing substrates at high temperatures. It utilizes component parts that if misused will cause injury.

The machine must only be used by personnel that have received training and are familiar with the process involved.

The machine has Residual Notices fixed to certain surfaces warning of risks that are present if due care is not taken. Make sure you read the notices carefully and understand why they are present.

The machine is fitted with an Emergency stop button to immediately stop the process and render the machine safe in the event of an emergency.

The EPO button must be checked regularly to ensure it functions correctly. With the machine running, press the EPO button. The machine must stop and the button will stay IN. Twist the button and it will release and return to its original position. The machine must not start at this time. Now press the reset or power on button and the machine should start. If this sequence is not correct-do not use the machine.

Safeguards are built into the machine if the top cover is missing or not attached. The extraction system is not connected or operational.

When leaving the machine for a long period-do not turn off with the EPO button, rather power down and isolate the machine at the circuit breaker.

Noise Level is greater than 70 db when processing wafers.

## Table of Contents

### SECTION 1: INSTALLATION PROCESS OVERVIEW

1.1 Installation Procedure .....	1-1
1.2 Required Tools .....	1-2

### SECTION 2: UNPACKING AND INSPECTING THE SYSTEM

2.1 Unpacking the System.....	2-1
2.2 System Inspection.....	2-2

### SECTION 3: INSTALLATION SITE REQUIREMENTS

3.1 System Dimensions .....	3-1
3.2 Electrical Connections .....	3-2
3.3 Gas and Cooling Requirements.....	3-3

### SECTION 4: UTILITY CONNECTION RECOMMENDATIONS

4.1 Overview .....	4-1
4.2 Oven Cooling Water Plumbing .....	4-2
4.3 Non-Process Nitrogen/Air Quartz Tube Cooling Supply.....	4-3
4.4 Process Gas Supply.....	4-4
4.5 Exhaust Plumbing.....	4-5
4.6 AC Power Connection.....	4-6

### SECTION 5: QUARTZWARE INSTALLATION (TUBE AND TRAY AND TC)

5.1 Quartz Isolation Tube Removal and Installation .....	5-1
5.2 Quartz Wafer Tray Removal and Installation.....	5-2
5.2.1 Tray TC Installation.....	5-2
5.3 Quartzware Cleaning.....	5-3
5.4 Quartzware Storage .....	5-4

### SECTION 6: SYSTEM POWER UP AND TESTING

6.1 Connecting the Computer to the Solaris System .....	6-1
6.2 Installing Software to the Solaris System .....	6-2
6.3 System Power-Up .....	6-3
6.4 Software Startup.....	6-4
6.5 RTP Controller Menu Page.....	6-5
6.6 Creating and Editing Recipes.....	6-6
6.7 Processing a Saved Recipe.....	6-7
6.8 Optimizing Recipes.....	6-8
6.9 Open Loop Processing.....	6-9
6.10 Thermocouple Calibrations.....	6-10

### SECTION 7: SYSTEM CHECKS AND CONFIGURATIONS

7.1 Communication Check .....	7-1
7.2 MFC Checkout .....	7-2



7.3 Administration Options .....	7-3
7.4 MFC Configuration .....	7-4
7.5 Password Controls.....	7-5
7.6 Engineering Constants Page.....	7-6
7.7 Recalling Old Data.....	7-7

**SECTION 8: TROUBLESHOOTING GUIDE**

8.1 Gas Leak Check Failure.....	8-1
8.2 Computer Problems.....	8-2
8.3 Heating Chamber Problems.....	8-3

**APPENDIX A: SYSTEM SPECIFICATIONS..... A-1**

**APPENDIX B: SPARE PARTS KITS.....B-1**

**APPENDIX C: HOW TO ORDER/RETURN EQUIPMENT .....C-1**

C.1 How to Order Equipment and Parts.....	C-1
C.2 How to Return Parts.....	C-2
C.3 How to Exchange Parts .....	C-3
C.4 What to Do When the System is Down.....	C-4
C.5 Maintenance Plans .....	C-5

**LIST OF FIGURES**

4-1 Rear Utility Panel.....	4-1
4-2 Optimal Cooling Water Supply Configuration.....	4-2
4-3 Recommended Non-Process Supply/CDA Configuration.....	4-3
4-4 Optimal Process Gas Supply Configuration .....	4-4
4-5 Solaris 150 Gas and Exhaust Connections .....	4-5
4-6 Recommended Solaris Power Distribution Diagram.....	4-7
4-7 Solaris AC Power Connections .....	4-9
4-8 Solaris 150 Chiller Unit and Controller .....	4-11
5-1 Heating Chamber Screw Location.....	5-2
5-2 Purge Inlet Fitting Location (Rear of Oven).....	5-3
5-3 Front Flange Screw Locations.....	5-4
5-4 Removing the Isolation Tube .....	5-5
5-5 Flange O-rings.....	5-5
5-6 Isolation Tube for Tray TC ... ..	5-7
5-7 Wafer Tray Installation .....	5-9
5-8 Leveling the Tray.....	5-10
5-9 Leveling Screw Locations (Top View) .....	5-11

# SECTION 1

## INSTALLATION PROCESS OVERVIEW

### 1.1 Installation Procedures

This manual describes how to install the Solaris 150 system and perform an operations check. These activities are outlined in the following sequence of steps.

1. Prepare the site utility connections.
2. Unpack the heating chamber, computer boards, chiller and any additional parts.
3. Inspect the system for damage or missing parts.
4. Connect the utilities to the SOLARIS system and chiller.
5. Install the quartzware.
6. Configure the computer and load the SOLARIS S/W software.
7. Power-up the system.
8. Confirm proper operation.
9. Check for temperature accuracy.

### 1.2 Required Tools

You need the following tools to install your Solaris 150 system:

- Allen wrench set (non-metric or SAE)
- Screwdriver set
- Open-end wrenches (non-metric or SAE)
- Latex gloves
- Test wafers

## SECTION 2

# UNPACKING AND INSPECTING THE SYSTEM

### 2.1 Unpacking the System

The Solaris 150 system is shipped in several containers: a heating chamber (oven) crate, accessories box(es) and a computer box.

To open these packages, follow the steps below:

1. Remove the clamps which hold down the top of the heating chamber crate.
2. Remove the packing material.
3. Lift out the heating chamber.
4. Carefully unpack the accessories from their boxes.

**Do not discard shipping crates and boxes. You may wish to use them later if the system must be returned to Surface Science Integration for repair.**

Use care when unpacking accessories and spares and check that none of the parts are damaged.

### 2.2 System Inspection

Visually inspect each unit for dents, scratches or other visible signs of shipping damage.

If you notice any shipping damage, notify the carrier immediately.

Compare the contents of the accessories box with the **Surface Science Integration** packing list to make sure all items have been shipped. Handle the quartzware with care. If any parts are missing or broken, notify **Surface Science Integration** immediately. [Appendix C](#) in this manual lists procedures and phone numbers to obtain replacement parts.

**The quartz isolation tube is shipped inside the oven. Open the oven door and verify that the isolation tube was not damaged during shipment.**

## SECTION 3

# INSTALLATION SITE REQUIREMENTS

### 3.1 System Dimensions

The dimensions of the Solaris 150 oven are 10.5" H x 23" W x 30" L.

In addition, space must be made available next to or underneath the oven for a desktop computer.

### 3.2 Electrical Connections

Power requirements vary between the United States, Japan and Europe.

Specifications for each is shown in [Table 3-1](#)

Specification	Equipment	Voltage	Frequency	Current	Phases	#Wires	Notes
USA	Oven	208/240	60 Hz	90 A Peak	1	3	1,2,3,5
	Computer	110-120	60 Hz	Variable	1	3	4
Europe	Oven	220/240	50 Hz	90 A Peak	1	3	1,2,3,5
	Computer	220-240	50 Hz	Variable	1	3	4
Japan	Oven	200	50/60 Hz	90 A Peak	1	3	1,2,3,5
	Computer	100	50/60 Hz	Variable	1	3	4

**Table 3-1. Solaris ® Power Distribution Requirements**

Note 1: Use an isolation transformer to reduce interference to other equipment(Optional).

Note 2: Locate oven within 25 feet line length of Junction Box.

Note 3: Locate power disconnect switch within reach of the system.

Note 4: Computer current will be dependent upon the computer manufacturer.

Note 5: Current Peak is 90 amps. Use Slo-Blow Fuse

Note 6. Customer Supplies Power cord and relief collar.

### 3.3 Gas and Cooling Requirements

Water, process gas, tube cooling and exhaust requirements are described below:

- **Water**

- **Type** Pre-filtered with conventional particulate filter to 100 microns. DI Water continuously conditioned to 0-5 Mohms Resistivity.
- **Inlet pressure** 60 psi (4.2 kg/cm<sup>2</sup>) typical; 80 psi (5.6 kg/cm<sup>2</sup>) maximum
- **Inlet temperature** 35°C maximum; 3° above dew point
- **Flow** 2 gpm (7.5 lpm) minimum
- **Pressure differential** 35-50 psi (2.5-3.5 kg/cm<sup>2</sup>)
- **Connections** Inlet: 3/4" male hose thread  
Outlet: 3/4" male hose thread

- **Process Gases for MFCs**

- **Types** Any non-corrosive purge gas regulated to 20 PSIG and pre-filtered to 1 micron.  
**Inlet Connection** 1/4" female swagelok fitting

- **Compressed Cooling Gas**

- **Inlet pressure** 20 psig (1.4 kg/cm<sup>2</sup>)
- **Flow** 10-15 SCFM (283-425 slpm) minimum
- **Cooling gas** Nitrogen or oil-and-water-free air, filtered to 3 microns
- **Connection** 1/4" female swagelok fitting.

- **Exhaust**

- **Oven Vent Connection(optional)** 20 scfm (566 slpm); 2" exhaust vent connected to house exhaust system
- **Oven Scrubber Connection** 10 slpm maximum; 1/4" female swagelok fitting connected to building scrubber system; Back pressure should not exceed 0.75" water

## SECTION 4

# UTILITY CONNECTION RECOMMENDATIONS

### 4.1 Overview

The notes in this Section are designed to help you connect the Solaris 150 system plumbing and other utilities in a practical and functional manner. This section also emphasizes certain practices and requirements that are considered especially important for system operation and serviceability.

All utilities are connected at the rear utility panel of your system.

### 4.2 Oven Cooling Water Plumbing

During wafer processing, cooling water flows through the Solaris heating chamber walls to remove excess heat. Adequate operation of the cooling water system is extremely important for proper system operation. At least 2 gpm of water should be flowing through the system during, and immediately after, wafer heating. A flow switch, located near the cooling water outlet, disables the lamps if the water flow falls below 1.5 gpm.

A solenoid allows water to flow through the heating chamber walls at the beginning of the first heating cycle. Water continues to flow for 4.5 minutes after the last cycle has been completed. The Solaris system switches the water flow off and on as needed to prevent heating chamber overcooling and to save water. A flow meter is required on the Solaris water supply line so that you can visually inspect the flow rate on a periodic basis. Pressure gauges installed on the system water inlet and outlet lines are very useful during system troubleshooting. (See [Figure 4-2](#).) To reduce particles in the water passages, use a 100 micron filter on the inlet line. In addition, a filter inspection should be part of the periodic maintenance routine. A compressed air fitting connected to the system water inlet line (See [Figure 4-2](#).) will allow you to easily carry out service procedures which require purging cooling water from the Solaris system. For facilities with particular water problems (e.g. low water pressure, hard water or dirty water), a closed-loop water cooling system is advisable.

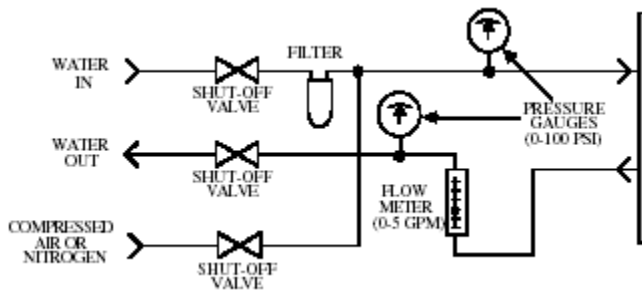

**Figure 4-2.** *Optimal Cooling Water Supply Configuration*

### 4.3 Non-Process Nitrogen/Air Quartz Tube Cooling Supply

Figure 4-3 shows the recommended configuration for the supply of nitrogen (N<sub>2</sub>) or compressed air (CDA), used for cooling the quartz isolation tube. The configuration illustrated below simplifies maintenance and troubleshooting activities. The nitrogen shutoff valve should be conveniently located so that the nitrogen can be turned off when the system is not in use.

**The tube cooling system is designed to operate with nitrogen. It is also acceptable to use compressed air, as illustrated in Figure 4-3.**

The *tube cooling system* is one of the most important systems in the Solaris system. During the heat cycle, cooling nitrogen or air flows around the exterior of the quartz tube and through the heating chamber, to maintain a consistent quartz temperature range. Adequate nitrogen or compressed air flow is critical to the proper operation of the system. A flow of 10 - 15 scfm is essential to ensure reliable and repeatable temperature measurement.

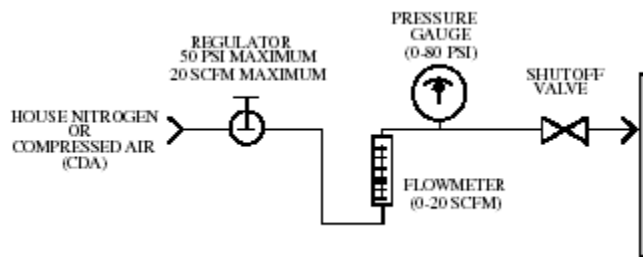

**Figure 4-3.** Recommended Non-Process Nitrogen Supply/CDA Configuration

### 4.4 Process Gas Supply

The Solaris 150 system can use one inert gas. The supply line for the process gas is connected to a 1/4" male VCR fitting on the rear of the Solaris . It is recommended that the tubing used for the process gas supply line be 316L stainless steel. This tubing is not supplied with the system.

**To minimize wafer contamination, all process gas supply tubing should be made of electropolished stainless steel.**

Process gas supply input pressure should be 20 psig..

Figure 4-4 shows the recommended configuration for the process gas supply system. You should connect the process gas exhaust outlet, also located on the rear of the Solaris to your facility scrubber. The outlet is a 1/4" female VCR fitting.

## CAUTION !

**Do not block the process gas outlet. This will cause pressure to build up inside the quartz isolation tube and it will break.**

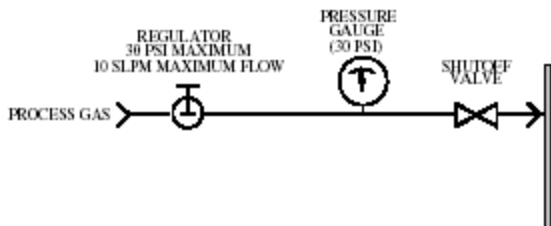

**Figure 4-4.** *Optimal Process Gas Supply Configuration*

### 4.5 Exhaust Plumbing

There are two exhaust outlets on the Solaris 150 that may need to be connected to your facility exhaust system..

- A process gas outlet, to carry spent process gases out of the heating chamber, should be connected to your facility exhaust system if there are hazardous materials present in the exhaust from the wafer process.
- An oven exhaust outlet, to carry nitrogen or CDA used to cool the heating chamber, should be connected to your facility exhaust system. The facility exhaust system should draw approximately 20 cfm of exhaust air from the Solaris cabinet. The purge gas outlet on the rear panel of the oven cabinet carries spent process gases. Depending on the type of wafers being processed, this exhaust may be toxic and hazardous. If this is the case, then the purge outlet must be connected to a *facility scrubber*.



## 4.6 AC Power Connection

The Solaris 150 systems are capable of heating single wafers very rapidly. This capability means that the Solaris has very high instantaneous current demands but sustained load is approximately 5-40 amps. Therefore, special care must be taken in connecting the AC power from the facility main AC lines to the Solaris . The main power lines from the facilities AC source must be kept as short as possible to reduce distributed line inductance, preferably with a line length of less than 25 feet. As the AC power distribution lines become longer, there is a higher resistance or distributed inductance in the wire. This distributed line inductance can result in power line disturbances if measured close to the Solaris AC power connections. These disturbances can result in the Solaris and other equipment on the same distribution panel having operational problems. To reduce the possibility of electrical interference with other equipment, it is recommended that the Solaris system be connected to a separate power distribution panel mounted close to the facilities main transformer. No other equipment should be connected to the same distribution panel and facilities isolation transformer as the Solaris. If more than one Solaris is installed in the same location, each Solaris should have its own distribution panel. The system should be connected to a customer-supplied time delay circuit breaker. Flexible armored cable is recommended to allow the system to be moved for easy maintenance access. Follow local electrical codes in making the electrical connections. In summary, the following guidelines should be followed when you connect Solaris 150 power in order to ensure proper system operation:

- Put the Solaris on a separate power distribution box from other equipment, preferably with its own power transformer. The power distribution box should be accessible from the system.
- Use the correct size circuit breaker for 90 amp peak, slo-blo fuse and house wiring (AWG #4 or larger).
- The distance from the Solaris system to the transformer should be as short as possible, preferably with a line length of less than 25 feet. A summary of the electrical requirements is shown in [Table 3-1](#).

Once the facility AC power and other facility connections have been routed to the Solaris system, use the following procedure and for connecting the AC power to the system

### **WARNING !**

**Make sure the AC power from the Solaris distribution panel is OFF before you begin this procedure. Even with the AC power switch on the front panel OFF, high voltage still exists on various components inside the system. Follow proper lockout/tag-out procedures.**

1. Remove the top cover from the Solaris 150 system.
2. Loosen the cable strain relief collar located on the rear panel of the system. See [Figure 4-7](#).
3. Solder a large ring lug to the green ground wire on the power cable.
4. Feed the power cable (No. 4 gauge or larger) through the strain relief collar.
5. Loosen the screws on the top of the contactor and connect the two power leads, securing the leads with the hold-down screws. The order of the leads is not important for proper system operation.
6. Connect the green ground wire to the ground lug on the bottom of the Solaris chassis.
7. Tighten the strain relief collar on the rear of the Solaris system and make sure that it is holding the power cable securely.
8. Do not install the top cover. Continue on to the next [section](#).

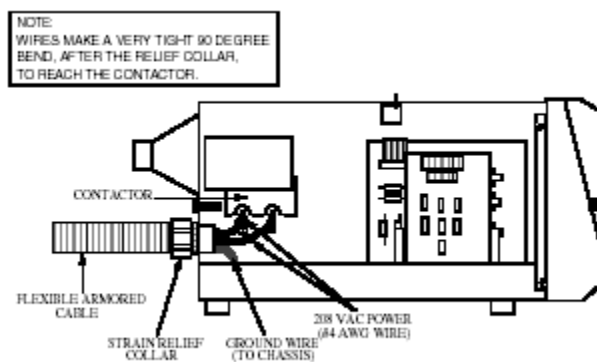

**Figure 4-7.** *Solaris AC Power Connections*

## SECTION 5

### QUARTZWARE INSTALLATION (TUBE AND TRAY AND THERMOCOUPLE)

The Solaris 150 system uses two major pieces of quartzware: the quartz isolation tube and quartz wafer tray. Solaris systems are normally shipped with the quartz isolation tube installed. The quartz wafer tray is shipped in a separate packing container. It is recommended that the quartz isolation tube be removed, inspected for damage and cleaned prior to putting the system in service. Procedures for removing and installing this quartzware are described below.

#### 5.1 Quartz Isolation Tube Removal and Installation

The quartz isolation tube may need to be removed from the heating chamber for cleaning if it becomes contaminated. A severely contaminated tube decreases the amount of energy that reaches the wafer and may also affect the Tray TC accuracy.

1. Obtain the following tools to remove and re-install the quartz isolation tube:

- Standard Allen Wrench Set
- Latex Gloves
- Phillips-Head Screwdriver

2. Turn off the main power to the Solaris system at the circuit breaker. Use Proper lock-out/tag-out procedures.

### **WARNING !**

**Make sure the AC power from the facilities to the Solaris is OFF before you begin this procedure. Even when the AC power switch on the front panel is OFF, high voltage still exists on various components inside the system.**

3. Open the oven door and remove the quartz wafer tray, if it is installed. The procedure for Wafer Tray Removal and Installation is later in this section.

4. Remove the top cover of the heating chamber cabinet. Remove top cover by lifting on rear of cover and then lifting complete cover upward.

5. On the rear of the oven assembly, loosen the knurled purge inlet nut securing the purge inlet connector to the rear of the oven. See [Figure 5-2](#). Remove the O-ring from the quartz nipple.

### **CAUTION !**

**Do not use pliers or other tools to remove the purge inlet nut. This will cause damage to the purge inlet fitting.**

## PURGE INLET NUT PURGE INLET CONNECTOR

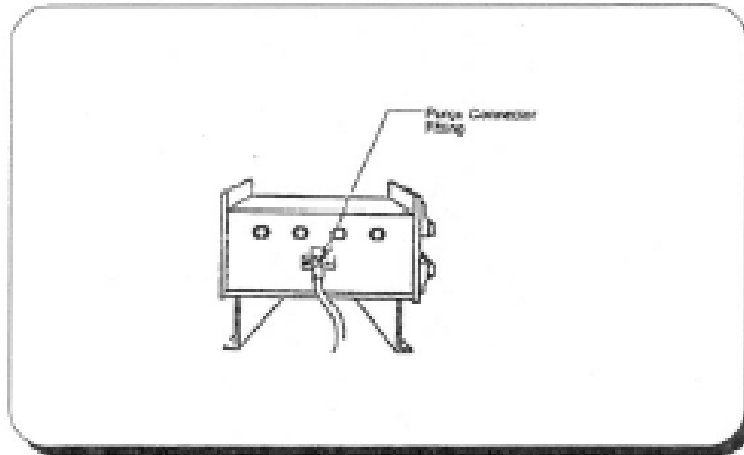

**Figure 5-2.** *Purge Inlet Fitting Location (Rear of Oven)*

1. Carefully remove the eight screws that hold the front flange in place. See [Figure 5-4](#). Put the screws in a safe place. Lay the flange forward on the rails for the oven door. Be careful not to damage the purge exhaust line.

### **CAUTION !**

**Do not remove any water lines or purge outlet fitting.**

7. Put on Latex gloves and, from the front of the system, gently pull forward on the quartz isolation tube. It may be necessary to gently move the tube from side to side or up and down while pulling the tube forward. See [Figure 5-4](#).

### **CAUTION !**

**Once the tube starts to come out, be very careful not to strike the tube against the lamps inside the oven chamber. Be careful not to strike the nipple of the isolation tube against the oven.**

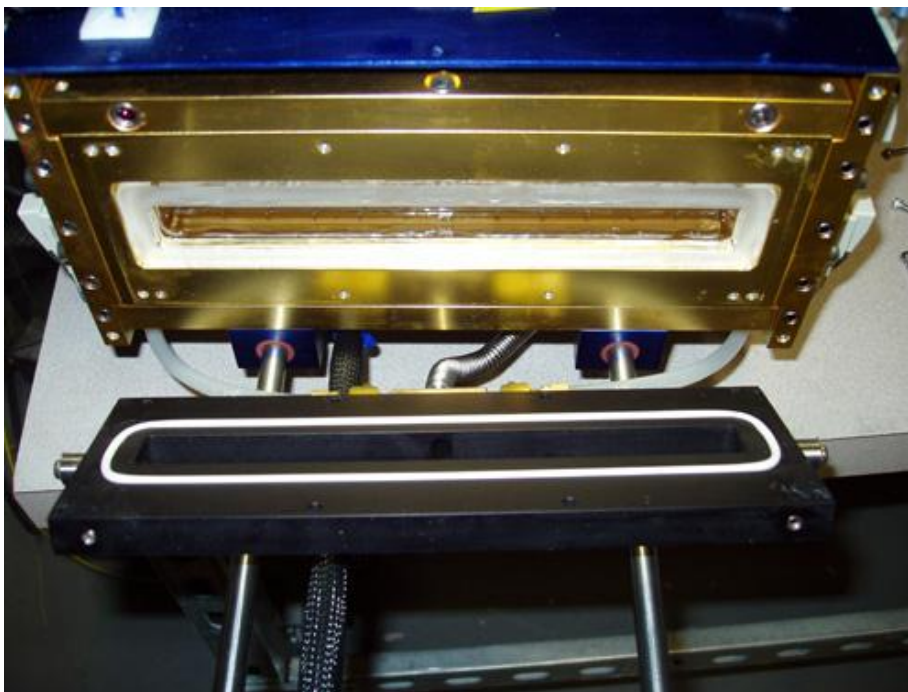

**Figure 5-4.** *Removing the Isolation Tube*

8. With the tube removed, examine the O-rings on the heating chamber flange surface and the rear purge fitting. Make sure that the O-rings are not damaged or burned; if they are, replace them.
9. Inspect the quartz isolation tube for any defects or scratches. Clean the isolation tube. The procedure is listed later in this section.
10. When you are ready to re-install the isolation tube, install the inner flange O-ring. See [Figure 5-4](#).
11. Install the isolation tube by inserting it straight back into the heating chamber.

## **CAUTION !**

**Use caution when inserting the isolation tube in the chamber to make sure that you do not strike the lamps. The tube nipple must be inserted through the hole in the rear of the oven.**

12. Install the outer flange O-ring into the groove of the flange, as shown in [Figure 5-4](#).
13. Place the front flange against the isolation tube flange and install the eight screws you removed earlier in this procedure. Tighten the screws evenly in a star-pattern, a little at a time.

## CAUTION !

Take special care when you install the screws to prevent stripping the soft aluminum flange. Be sure the outer flange O-ring is still in its proper position before tightening the screws.

14. Install the purge inlet O-ring.

## CAUTION !

**Tighten the purge inlet nut finger tight only. Do not use pliers or other tools to tighten the purge inlet nut. It will damage the purge inlet nut and fitting.**

15. Install the purge inlet connector. Ensure that this connector is only handtightened. Do not use any tools to tighten this connector.

## CAUTION !

**The back purge fitting base must not be tight against the oven. It must be loose to allow for expansion during heating cycles. When tightening the nut, push in on the fitting so that it is flush with the oven.**

16. Perform an oven leak check to make sure that the quartz tube is properly positioned and sealed when the oven door closes. Oven leak checks should be performed by processing a TiSi wafer and checking for excessive O<sub>2</sub> contamination.

## CAUTION !

**Do not use leak check procedures involving pressurization of the quartz tube. This will cause damage to the tube.**

17. Reinstall the wafer tray following the procedure for Wafer Tray Removal and Installation.

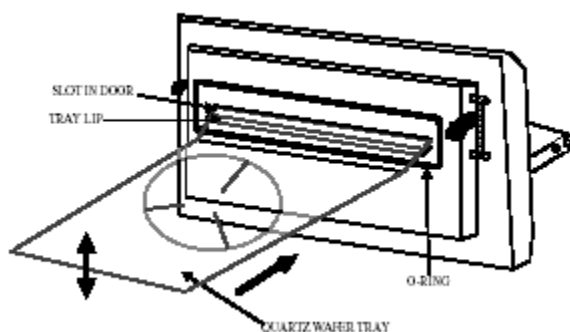
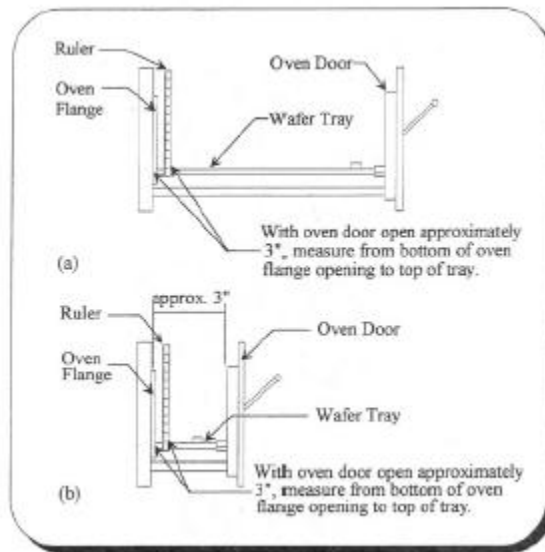

Figure 5-7. Wafer Tray Installation

## 5.2 Quartz Wafer Tray Removal and Installation

1. Open the oven door and pull it all the way out.
2. If a thermocouple wafer or cantilever thermocouple is installed, carefully remove it.

3. Using Latex gloves, carefully lift up on the end of the tray closest to the oven. The tray will lift off from the oven door flange support bracket.
4. Inspect the tray for damage. Clean the tray, if required, following the instructions later in this chapter.
5. Place the tray on a clean surface, preferably quartz.
6. Perform any additional procedures that need to be done while the tray is removed from the system.
7. Reinstall the tray with the wafer support pins up. Place the support edge of the tray on the flange support bracket while lifting the end of the tray closest to the oven. The tray will fit into the flange support bracket. Lower the end of the tray closest to the oven. See



**Figure 5-8.** *Leveling the Wafer Tray*

8. In order to achieve optimum process uniformity, it is very important that the wafer tray be level with respect to the Solaris oven. Close the oven door until the edge of the tray is flush with the oven flange. See [Figure 5-8](#) (a) and [5-9](#). Using a ruler, measure the distance from the bottom of the oven flange to the top edge of the wafer tray. Measure the tray on both sides to verify that it is level from side to side.
9. If the tray is level from side-to-side, go to the next step. If the tray is not level side-to-side, then adjust the tray using the leveling screws. The level of the tray should be adjusted so that the end of the tray is centered with the opening in the oven flange. See [Figure 5-9](#) for location of oven leveling screws. Once the tray has been leveled from side to side, note the distance from the bottom of the oven flange to the top edge of the wafer tray.

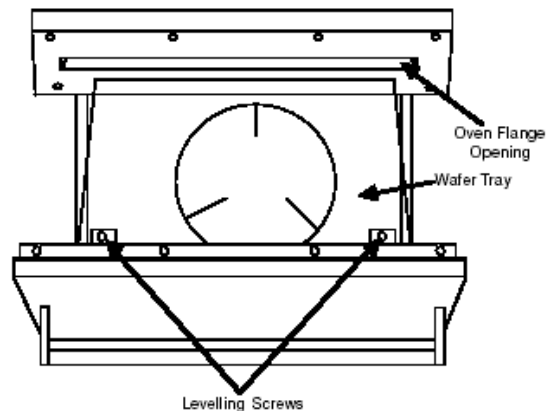

**Figure 5-9.** *Leveling Screw Locations (Top View)*

10. Close the oven door until it is open about 3 inches. See [Figure 5-8 \(b\)](#). Using a ruler, measure the distance from the bottom of the oven flange to the top edge of the wafer tray. This distance should be the same as the distance noted in step 8 or step 9 above. If it is the same, then the wafer tray is level. If it is not the same, then the tray will need to be leveled from front-to-back using the leveling screws. See [Figure 5-9](#) for leveling screw locations.

11. Repeat steps 8 through 10 to verify that the wafer tray is level. The distance should be the same between the bottom of the oven flange and the top of the wafer tray on both sides of the tray with the door almost open and near the front of the tray with the door open only 3 inches.

**There may be some movement of the tray from left to right. This movement is normal and should not be a reason for concern.**

12. Place a wafer on the tray. Slowly close the door of the heating chamber. Listen for any scraping sounds that may mean that the quartz is not properly aligned. If you notice any scraping sounds or resistance to door movement, realign the tray and repeat this step.

## **CAUTION !**

**To avoid damaging the quartz tray, do NOT force the heating chamber door.**

### **5.2.1 Tray TC Installation**

The TrayTC Thermocouple is the primary temperature measurement device in the Solaris. It is a fast response high temperature thermocouple that has been designed to be permanent in the process chamber. Unlike pyrometers, the Tray TC does not need



calibration to compensate for various wafer backside emissivities. For pyrometers, unless calibrated for every backside condition the temperature variance from one wafer backside film to another may cause temperature measurement errors of over 60 degrees. The Tray TC is as close to being emissivity independent as possible without the use of very advanced and cost prohibitive pyrometry systems.

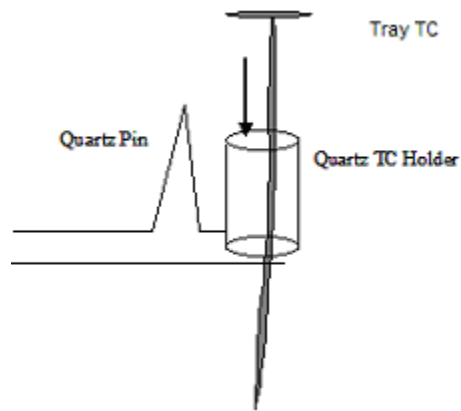

**Figure 5.10**

## To install the Tray TC:

Always use gloves when handling the Tray TC.

Carefully feed the TC wires and ceramic sheathing through the Quartz TC Holder on the quartz wafer tray.

Unscrew the TC feed-through screws on the oven door. The left side TC screws are for the Tray TC, the right side TC feed-through screws are for the calibration K-Type TC wafer.

The long wire of the Tray TC assembly is the negative terminal. This wire will be attached to the fatter TC feed-through screw. The short wire is the positive side. If the temperature does not measure correctly or the temperature drops upon heating, the TC wires are reversed and must be switched.

Gently place the SiC cap on top of the Tray TC and the Quartz TC holder.

Reinstall the top cover on the Solaris system if it has been removed.

## Installation of K-Type TCs

Note:

Red TC(positive) Lead Connects to the larger to the thin or right side screw.

Thermocouple Feed-through or left side screw . The clear or non-marked, magnetic(negative) TC lead connects to the larger Thermocouple Feed-through or left side screw

### Tray Leveling Screws

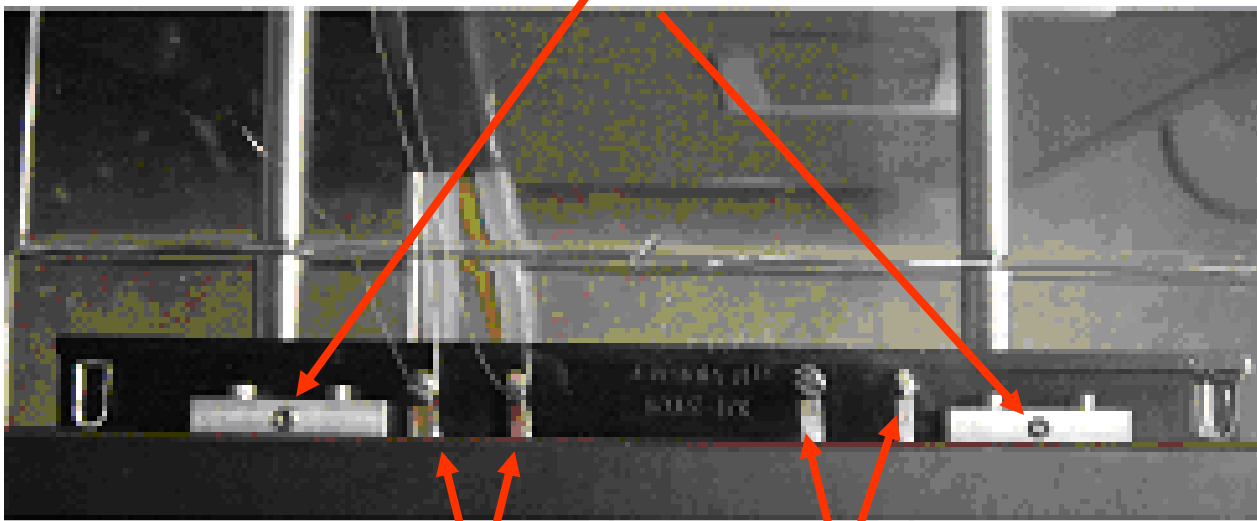

**Tray TC Connections**

**K-Type TC Connections**

Checking Thermocouple Operation

1. **Power-up the system if it is off.**
2. **From the *Main Menu* to go to the *System Diagnostics* screen.**
3. **Insure that the TC Assembly is installed correctly.**
4. **Enable the lamps, and increase the lamp intensity to 15%.**
5. **Observe the temperature feedback of the thermocouple display**
6. **Upon successful monitoring of temperature feedback the system is ready for TC controlled**

### 5.3 Quartzware Cleaning

To ensure uniform wafer heating, the quartz isolation tube and wafer tray must be kept clean. Thin films deposited on the quartzware may not be visible. If there is a loss of heating uniformity, clean the isolation tube and wafer tray, even if no deposits are visible. The quartzware should also be cleaned prior to performing a temperature calibration. How frequently the quartzware needs cleaning depends upon the amount and type of processing being performed. Generally, it should be cleaned at least once per month. Check the tube frequently to see if any films or other deposits can be observed.

## **WARNING !**

**Always use caution when handling chemicals to prevent injury or burns.**

**NOTE:** The quartz ware isolation tube and the quartz wafer tray must be always handled with latex gloves to avoid contamination.

To ensure uniform wafer heating, the quartz isolation tube and the wafer tray must be kept clean. Thin films deposited on the quartz ware may not be visible. If there is a loss of heating uniformity, clean the isolation tube and wafer tray, even if no deposits are visible. The quartz ware should also be cleaned prior to performing a temperature calibration.

**CAUTION:**

Be very careful not to break the pins when cleaning and handling quartz wafer trays.

1. Obtain the following cleaning materials:

Concentrated Nitric Acid

Semiconductor Grade Soap

Semiconductor Grade Sponge / Cleaning Pad or Cleaning Brush

10% Hydrofluoric Acid

Deionized Water

Clean Dry Nitrogen

2. If stains / deposited material are visible on the quartz ware, scrub with “hot” (warm to the touch) deionized soapy water until all visible residue is removed.
3. Rinse with deionized water for 10 minutes
4. If stains are still visible on the quartz ware, soak in concentrated nitric acid; otherwise, proceed to Step 6.

5. Rinse with deionized water for 10 minutes.
6. Soak in 10% hydrofluoric acid, for no longer than 1 minute, or excessive etching will occur.
7. Rinse with deionized water for 10 minutes.
8. Blow quartz ware dry with clean, dry nitrogen.

## **CAUTION !**

**Be very careful not to break the pins when cleaning and handling quartz wafer trays.**

### **5.4 Quartzware Storage**

The quartz isolation tube and the quartz wafer tray must be handled with lint-free gloves to avoid contamination. When storing the quartzware, it is extremely important to do so with the minimum possibility of contamination.

## SECTION 6

### SYSTEM POWER-UP AND TESTING

#### 6.1 Connecting Your Computer to the Solaris System

Connecting the computer to your SOLARIS 150 system simply consists of connecting the appropriate cables between the computer analog input/output cards and the SOLARIS oven chamber. The computer has two National Instruments PCI cards, the bottom card will always connect into the bottom slot in back of the Solaris. The top connection will connect to the top PCI card on the computer

#### 6.2 Installing the SOLARIS S/W Software on Your Computer

The SOLARIS S/W software programs were shipped installed on the PC with specific drivers for the Solaris system. If for any reason the computer fails, the user must contact Surface Science for installation procedures of the operating software.

This section describes the procedures for powering-up the system and the test procedures that must be performed directly after power-up to ensure safe Solaris system operation.

#### 6.3 System Power-Up

You are ready to power-up your Solaris 150 at this point in the installation procedure. The following steps describe the power-up sequence.

### CAUTION !

**Be alert at all times during the initial power-up procedures. If at any time during these initial procedures the lamps turn on at high intensity unexpectedly, immediately turn the power switch OFF. The system can heat up a wafer very rapidly until it melts. This can cause extensive damage to the Solaris.**

1. Connect the AC power cord of the computer to an AC outlet.
2. Switch on the facilities circuit breakers for the Solaris .
3. Power up the computer following the computer manufacturer's instructions.

### CAUTION !

**Always power up the computer before turning on the power to the heating chamber.**

4. Turn on the heating chamber using the front panel power switch. A green light indicates that the system is on. You will also hear a "clunk" when the switch is activated. This is the sound of the contactor engaging.
5. Turn on the water and tube cooling air or nitrogen.

## 6.4 Software Installation and startup

The instructions below assume that you are familiar with the operation of your computer, and that the SOLARIS software is installed on the computer. All keyboard input to the computer is in boldface type, and <CR> means to press the Return key on the computer keyboard.

If the SOLARIS software has not been installed on your computer, copy or drag the contents from the supplied CD from Surface Science Integration onto the desktop. Click on the Solaris icon on the desktop to start the software.

**Note: Boot up the computer and start the SOLARIS software prior to turning on the power to the Solaris oven.**



The three icons that are available include:

**Start RTP Process:** This icon will allow the user to create recipes, run the Solaris, troubleshoot problems and perform diagnostic checks.

**Help Information:** Gives information on the software version, contact information and manuals.

**Exit Controller:** Exits the SOLARIS program and returns the user to the desktop.

## 6.5 RTP Controller Menu Page

The RTP Controller Menu Page allows the user to create/edit recipes, run stored recipes and perform diagnostic tasks and system checks. The following options are described in detail.

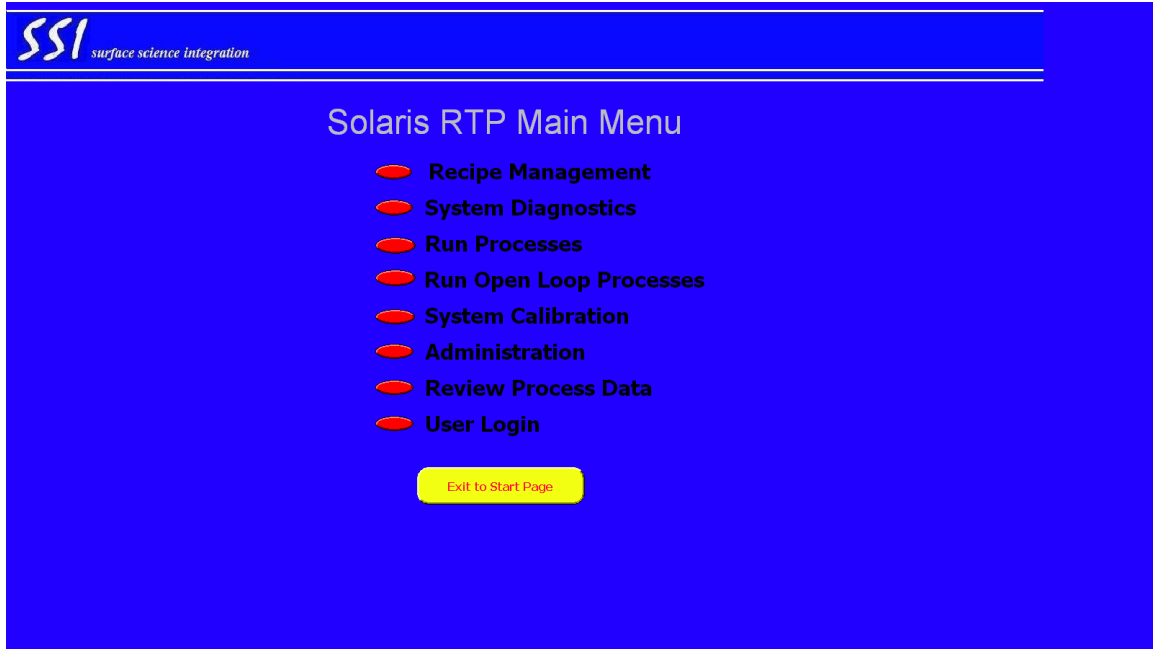

**Recipe Management:** Create and edit process recipes including temperature profiles, gas control, temperature measurement method, PID coefficients and calibration recipes.

**System Diagnostics:** System diagnostic checks including manual operation, Tray TC calibration, lamp and MFC checks.

**Run Process:** Allows the user to run stored recipes and includes a graphical temperature profile and real time data collection.

**Run Open Loop Process:** Allows the user to 'playback' previous saved process profiles in an open loop mode without control or feedback to the thermocouple.

**System Calibration:** Used to calibrate the Process Thermocouples and setup of calibration curves to compensate for thermal transfer errors.

**Administration:** Allows setup of passwords and password protection for recipe editing, file management and MFC configuration.

**User Login:** Inputs User data to be saved with each process run.

**Exit:** Returns the user to the SOLARIS start page.

## 6.6 Creating and Editing Recipes

This section identifies the various aspects of creating a recipe in the SOLARIS software. The SOLARIS software allows specific tailoring of recipes for error compensation and to reduce under and overshoots.

The first step in creating a recipe is to give the recipe a name. The software will prompt the user to either create a new recipe or edit a current recipe. For a new recipe simply type the name of the recipe will appear in the current file box.

**SSI surface science integration RTP Recipe Editing Page**

**Control Parameters:**

- Step #: 5
- Control Temperature, °C or Ramp Temp Limit, °C: 300
- Operation Type: Finish
- Step Time for Hold Step or Ramp Rate for Ramp Step: 30
- Control Device: Tray TC
- Initial Intensity for Hold Step or Ramp Exit Modifier: 0.00

**P.I.D. Values:**

- P Value: 0
- I Value: 0
- D Value: 0

**Local Lamp Power Percentage:**

- Upper Rear Lamp Power: 100
- Upper Front Lamp Power: 100
- Lower Lamp Power: 100

**Mass Flow Controllers:**

- Nitrogen: 10.0 SLM
- Argon: 0.0 SLM
- Oxygen: 0.0 SLM
- Argon: 0.0 SLM
- Oxygen: 0.0 SLM
- Argon: 0.0 SLM

**Current Recipe:** 500 degree 30 sec 100mm SLtst

**Control Buttons:** Insert Line, Remove Line, Delete Last Line, Delete All Lines, Exit

**Save Buttons:** Save, Save As

Step#	Operation	Control Temp	Ramp Rate/Step Time	REM Intensity	Control Device	Nitrogen	Argon	Oxygen			P Value	I Value	D Value	LR/PL	UR/FL	LLP
1	Purge	0.0	300.0	0.00	Tray TC	10.0	0.0	0.0	0.0	0.0	0.0	0.0	0.0	100.0	100.0	100.0
2	Ramp Up	500.0	40.0	20.00	Tray TC	10.0	0.0	0.0	0.0	0.0	0.0	0.0	0.0	100.0	100.0	100.0
3	Hold	500.0	30.0	37.00	Tray TC	10.0	0.0	0.0	0.0	0.0	50.0	0.0	0.0	100.0	100.0	100.0
4	Ramp Down	300.0	200.0	0.00	Tray TC	10.0	0.0	0.0	0.0	0.0	0.0	0.0	0.0	100.0	100.0	100.0
5	Finish	300.0	30.0	0.00	Tray TC	10.0	0.0	0.0	0.0	0.0	0.0	0.0	0.0	100.0	100.0	100.0

The numerous input boxes and pull down menus on the recipe page are used to create and optimize your recipe profiles. The user inputs are divided into three sections: Control Buttons, Data Entry and the Recipe Matrix.

**Current File:** The name of the recipe being created or edited. Note: even though the recipe and calibration files end with .txt, the user does not enter the .txt designation at the end of the file.

**Save and Save As Recipe:** Once a recipe has been created, use the **Save Recipe** button to save the file.

**Delete Last Line:** Deletes the last step in the recipe.

**Delete All Lines:** Clears the recipe matrix box.

**Step:** Identifies the current recipe step



**Operation Type:** This pull down box identifies which type of operation the current step is to perform, the choices are **Purge, Ramp up, Hold, Ramp down and Finish.**

**Control Device:** The user chooses which temperature monitoring device to be used with the current recipe. This can be **Tray TC** control or **K-Type Calibration Wafer** control.

**Control Temperature:** Identifies the steady state or setpoint temperature.

**Ramp Rate Box and Step Time:** Identifies the time at steady state if the **Hold** operation is selected for the step or the purge time if the **Purge** operation is selected for the step. If the step operation is a **Ramp Up** or **Ramp Down**, this box sets the ramp rate in degrees/sec.

**Note: The last recipe process step will always be the Finish Step**

**Local Lamp Power:** New to Solaris Version 3.0 software is the ability to control the lamp intensity in separate zones of the process chamber. The user is able to tailor the wafer uniformity by varying the upper lamps in two separate zones. The UFLP(upper front lamp power) designates the five upper lamps closest to the door. The URLP (upper rear lamp power) designates the five upper lamps closest to the back of the system. The LLP (Lower Lamp Power) controls the bottom 11 lamps. The intensity of the individual lamp zones can be controlled in increments of 1% from 0-100%. To adjust uniformity it is recommended to adjust one upper lamp zone at a time.

In addition to adjusting uniformity, the Solaris 3.0 software allows the user to run with either the top bank of lamps or the bottom bank. To run with only the top lamps, simply set the LLP to 0%. To run with only the bottom lamps, set the UFLP and the URLP to 0%. Note, with one set of lamps heating, the ramp rates and maximum temperature of the unit will be reduced.

**REM/Intensity:** This is a dual use box. For Ramp steps the parameter in the recipe is REM(Ramp Exit Modifier). For Steady State Hold steps the parameter is Percent Lamp Power. The REM setting identifies a point in the Ramp Up state in which the closed loop temperature control starts making a transition from the ramp up step into the steady state anneal. Generally the **REM** will be set at a level equivalent to the overshoot when the **REM** value is set to zero. For instance if an initial recipe is run and the overshoot is 20 degrees, the **REM** should be set at 20. For high ramp rates a general rule is to set the **REM** to 1.5 times the overshoot.

During the steady state hold step the **Percent Lamp Power** value corresponds to the lamp intensity where the temperature at steady state is optimized for a particular process. The Percent Lamp Power value is self-adjusting and is changed by the control software as particular recipe being created or edited. For initial recipes setup, use the following graph as a guide.

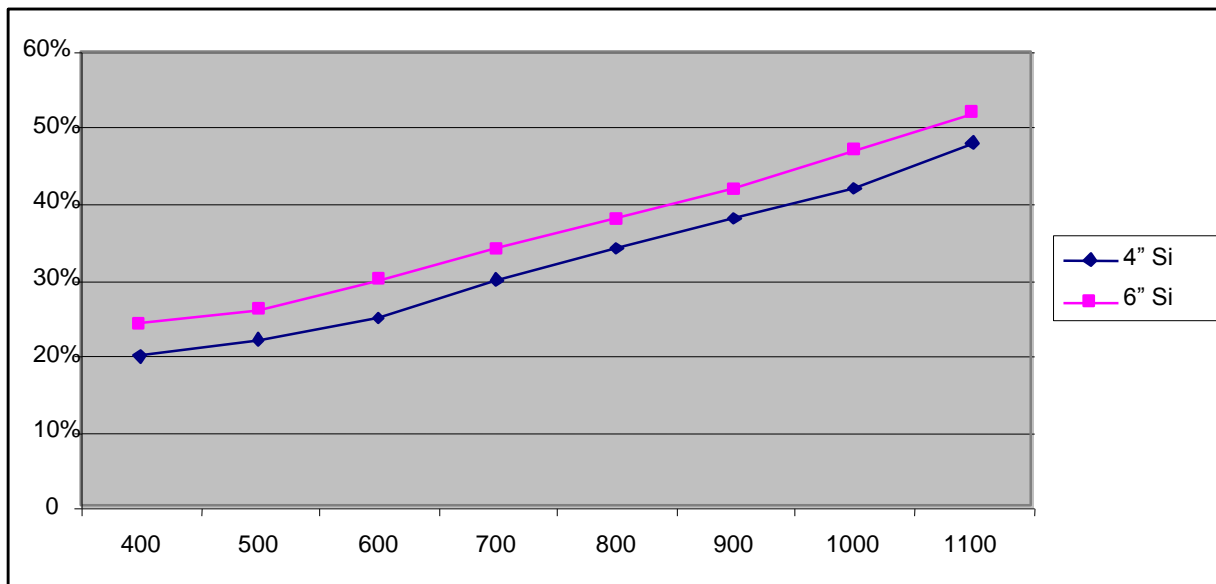

**PID Parameters:** This GUI window provides the values for the controller parameters obtained from the control-relevant model reduction step. The PI, PID and PID with filter parameters are shown and can be subsequently changed to either slow or speed up the closed-loop speed of response. The Proportional, Integrated and Derivative Gain parameters are used to optimize the steady state of the Solaris. These values are active in the **Steady State Hold** step. For most processes the PID values will be set to zero.

The **Proportional** gain corrects for steady state gain errors. If the controller is too slow in reaching steady state from the ramp step the **Proportional** value can be increased. The values will be changed in levels of +/- 5. If a recipe is optimized with the REM and intensity levels set correctly, the **Proportional** value will be set at zero.

The **Integrated** gain parameter should be used if there are oscillations of the temperature above and below the desired setpoint. Increasing the **Integrated** gain decreases the amplitude of the oscillations. Decreasing the **Integrated** gain will help reduce the oscillations such that the variation in steady state hold temperature will be reduced. The **Integrated** gain value is generally increased in values of +/- 20.

The **Derivative** gain value helps the controller change the correction factor if there are very rapid changes in temperature error around the setpoint. The values of **Derivative** gain will be values of +/-10. But again in general for most processes this value will be set to zero.

## Process Time Limitations

Temperature	Maximum Time(min)
1200	2.0
1150	2.5
1100	5.0
1050	5.5
1000	6.0
950	6.5
900	7.5
850	8.5
800	10
750	12
700	15
650	20
600	30
550	45
500	60
450	76
400	85

Although the Solaris RTA system is usually used for fast ramp anneals for short periods, occasionally users would like to run processes for extended periods. SSI recommends not exceeding the above chart however if extended process runs are required, SSI offers an advanced cooling upgrade that allows processing samples for longer periods. Contact SSI for details.

## Ramp Rate Optimization

The Solaris software in relation to ramp rates is optimized for a 100mm silicon wafer. Although the s/w has a self-adjusting correction routine to in order to best keep the ramp rates accurate on average, the user is also able to optimize ramp rates by using the **Proportional** gain factor in the ramping step. If ramp rates are slow, for instance with a susceptor or a thick silicon wafer, the **Proportional** gain value can be increased in steps of 0.5 starting at a value of 1.0. Roughly a value of 1.0, will double the ramp rate. If ramp rates are too high, for example in processing 3" silicon of very thin substrates, the Proportional gain parameter can be lowered to fractional levels. Roughly, a **Proportional** gain value of 0.5 will decrease the ramp rate by ½.

## 6.7 Processing a Saved Recipe

Once a recipe has been created, the next step is to optimize the recipe to obtain the best process performance. Several runs may be needed before a process is complete. The following page is a screen shot of the Solaris Process page. In this section the user can monitor the process parameters in real time with either the graphic display or by readout control boxes.

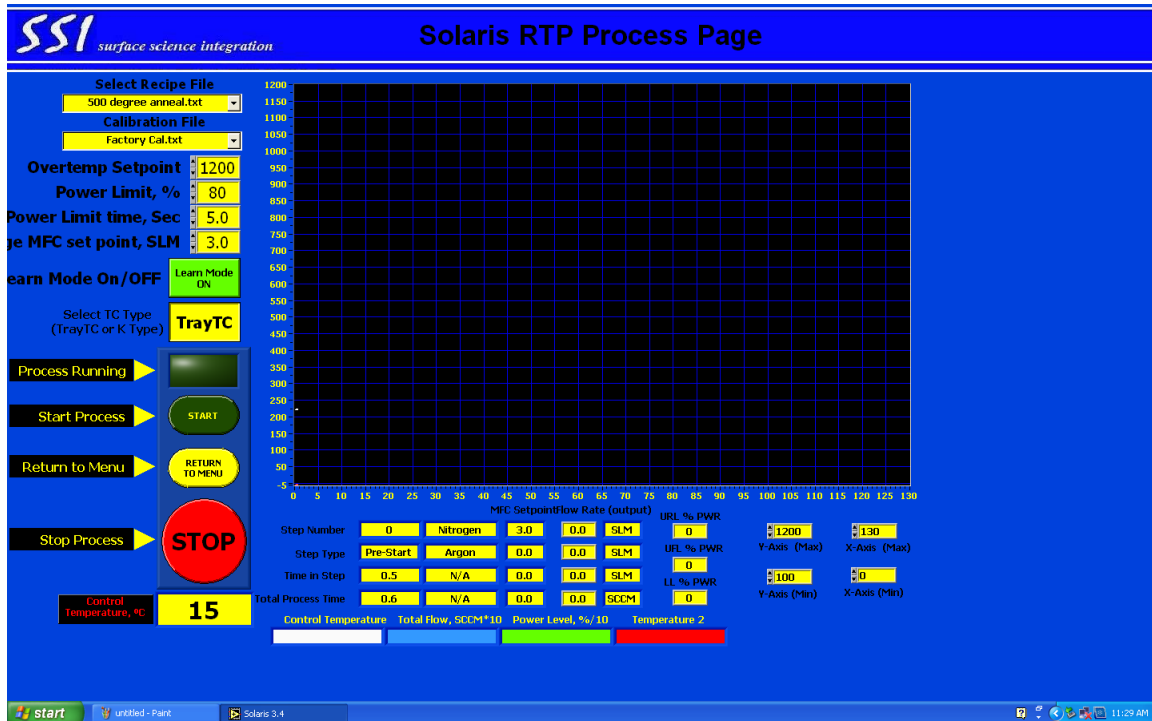

To run a recipe use the **Select Recipe Name** pull down box to load the recipe parameters. By choosing a specific recipe, next, choose the Tray TC calibration file associated with the recipe from the pull down menu..

The **Learn Mode** Icon can be set to on or off. If a new recipe is being optimized the **Adaptive Learn** box should be set to **ON**. The **Adaptive Learn** algorithm in the process controller is a fuzzy logic routine in which data from the initial run is used to adjust the steady state intensity control independent of wafer type and size. You will notice that once the first wafer has been processed the **Steady State Intensity** value of the recipe will be changed to a new value. The SOLARIS controller will continue to adapt as more wafers are processed without the Adaptive Learn icon being toggled to **ON**. If the tool has not been run in the past 30 minutes, it is advisable to run a warm up wafer. This allows the chamber and quartz to be stabilized prior to processing a production wafer. The so called 'First Wafer Effect' which describes a slight process difference in wafer results from a cool chamber run versus a warm chamber will be eliminated.

The recipe step, time in process, temperature and gas flow will automatically be monitored in their respective display boxes. The temperature will be displayed in both the display box and the time/temperature graph in real time.

For extended process times or temperatures use the **Time Scale** and **Temperature Scale** toggles to change the display for better viewing.

To abort a recipe the user can depress the stop button or hit any key on the keyboard to stop the recipe.

**Note: Depressing any key on the keyboard will abort the Process**

Once a process has been completed the software will prompt the user to save the process run conditions. By answering **Yes**, the process data will be stored to a user defined data log. The data log file is a two-dimensional matrix of time versus measured temperature. By answering **Next Wafer**, the process data is permanently deleted.

Within the SOLARIS software the user can choose to flow N<sub>2</sub> through the chamber during wafer transfer. This is accomplished by using the Purge MFC command. Set the flowrate to a desired value by toggling the up/down arrows. The gas will flow until the command is set at zero regardless of whether the software is running or not. **Caution: When running the chamber purge gas will flow until the user shuts off the flow.**

### **RUN PAGE SAFETY FEATURES**

The Solaris software has several safety features that prevent the system from being damaged due to a temperature measurement or thermocouple error. The safety features are displayed in the upper left hand corner of the Run page. These features include an OverTemp Setpoint and Power Limit.

The **OverTemp Setpoint** is used to set the maximum temperature the tool will reach before it will abort. This command is used to set a software interlock in order to not damage the wafer being processed or the thermocouple. The Solaris has hard wired temperature interlocks on the oven to prevent oven damage in case of unexpected thermal runaway from an incoming power spike or drop-off.

**Note: The maximum safe temperature for the Solaris should be set for 1200°C**

**Note: The maximum combined flow rate of all MFCs cannot exceed 10 SLM. Damage to the Quartz tube may occur**

The **Power Limit Setpoint** is used in conjunction with the **Time Limit Setpoint**. These settings allow the user to set an upper limit on the Lamp power levels during a process

for a specified time. For instance if the Power Limit is set to 80% and the Time Limit is set for 3 seconds, the software will monitor the power levels and if the power level exceeds 80% for three seconds, the process will abort. The user can monitor the power level in the graph portion of the Run Page to determine where the Power Limit should be set. Note, it is advisable to set the Power Level at least 10% higher than the maximum power seen during a process step.

## **6.8 Optimizing a Recipe**

The Solaris SOLARIS software controller has been optimized for most process steps the user will encounter. The controller has to process a multitude of data in order to actively control within a specific range. In most cases, recipe tuning can be accomplished by adjusting the REM value in the Ramp step and Intensity in the Hold step. These are considered to be global controls and generally have the largest effect on tuning a recipe. The PID controls can help fine-tune a recipe beyond what the REM and Intensity controls can accomplish.

### **For Overshoot conditions:**

If the ramp rate is high, increase REM in the Ramp step by a factor of 1.0 times the amount of overshoot when REM is set to zero.

- Increase the Proportional Gain in the Hold step to a higher value. In increments of 5
- Increase the Integrative factor in increments of 20.

### **For Undershoot Conditions:**

- Run several test wafers to ensure the oven is warm
- Decrease the REM value. For very slow ramp rates REM may require a zero value.

### **For Steady State Oscillations:**

- Decrease the Proportional Gain in the Hold step to a lower value. In increments of 5.
- Decrease the Derivative Gain in increments of 5.
- Increase the Integrative factor in increments of 10.
- Clear all PID values and Re-run a process with the Adaptive Learn set to ON

## **6.8b General Starting Values For Recipe Tuning**

Because the cooling characteristics of a wafer are different at high temperatures versus low temperatures, the PID controls for recipe optimization will be different. At lower temperatures, the wafer cooling is dominated by heat conduction as opposed to high temperature processes in which the cooling mechanism is dominated by radiation. For S/w Version 3.0 with zone control the following general parameters provide a helpful starting point in recipe optimization.

**Low Temps <600**

REM value is 1.5 x Ramp Rate, P=20-40

**Mid Temps 650-900**

REM value is 1.0 x Ramp Rate, P=0-15

**High Temps 950-1200**

REM value is 0.5-1.0 x Ramp Rate P=0-5

**6.8c Using the Learn Mode**

The Solaris Learn mode will optimize a recipe within one or two runs. With the Learn mode turned on the Solaris S/W analyzes the process run and feeds back the REM and Power Percentage values that best suits the particular recipe. These values are automatically inputted into the recipe. In general after the first process run, the recipe is optimized, in some cases a second Learn run will be needed. Note: the Learn mode should not be used if the process run has an undershoot condition. In other words once a recipe has been optimized the Learn mode should be turned off. The calculation within the Solaris S/W adds the overshoot value of the process run to the REM value that currently is in the recipe. If an undershoot condition exists, the undershoot will be compounded by using the Learn mode.

**6.8d Examples of the Learn Mode**

In this example we will show how the learn mode is used to optimize a 500 degree anneal. The starting recipe is as follows:

Step	Operation	Control Temp	Ramp Rate/Step Time	REM/Intensity
1	Purge	0	30	0
2	Ramp Up	500	50	10
3	Steady State	500	30	17
4	Ramp Down	400	200	0
5	Finish	400	0	0

In this recipe the Solaris Ramps to 500 °C at 50 °C/sec. With the Ramp Exit Modifier set at 10 degrees, the Solaris will exit the ramp at 490°C and proceed into the steady state hold step. The substrate will be annealed for 30 sec and finally ramp down to 400 °C.

The first run profile is shown below:

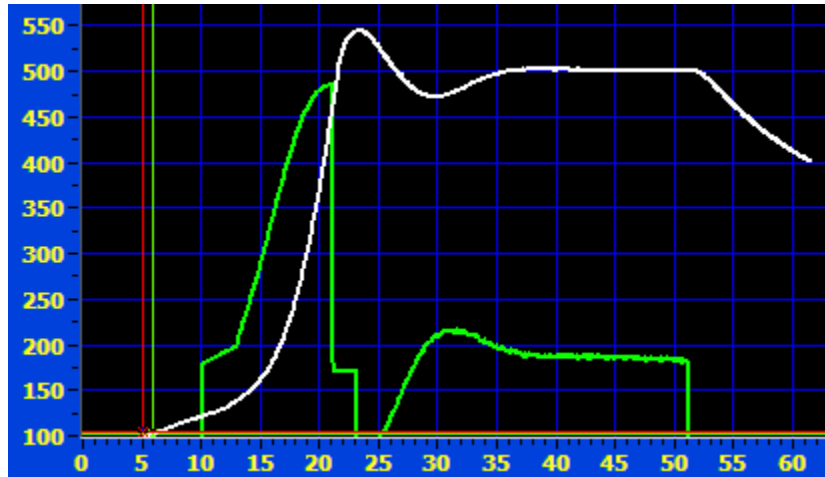

**Initial Process Run**

The overshoot of the initial recipe is around 40 degrees. With the learn mode turned on, the Solaris will feedback this value to the recipe and add it to the current REM value of 10 degrees. In addition the power percent level at steady state is set too low in the initial recipe. The Solaris S/W will readjust this value from a current percentage of 17% to a new value that corresponds to the correct power at 500 degrees.

The new recipe with the Learn mode on is as follows:

Step	Operation	Control Temp	Ramp Rate/Step Time	REM/Intensity
1	Purge	0	30	0
2	Ramp Up	500	50	52
3	Steady State	500	30	18
4	Ramp Down	400	200	0
5	Finish	400	0	0



As seen in the above table, the 42 degree overshoot of the initial run was added to the initial REM value of the Ramp Up step. In addition the Intensity percentage in the hold step was adjusted for a slightly higher value of 18%. The optimized recipe as displayed below is much more stable and consistent.

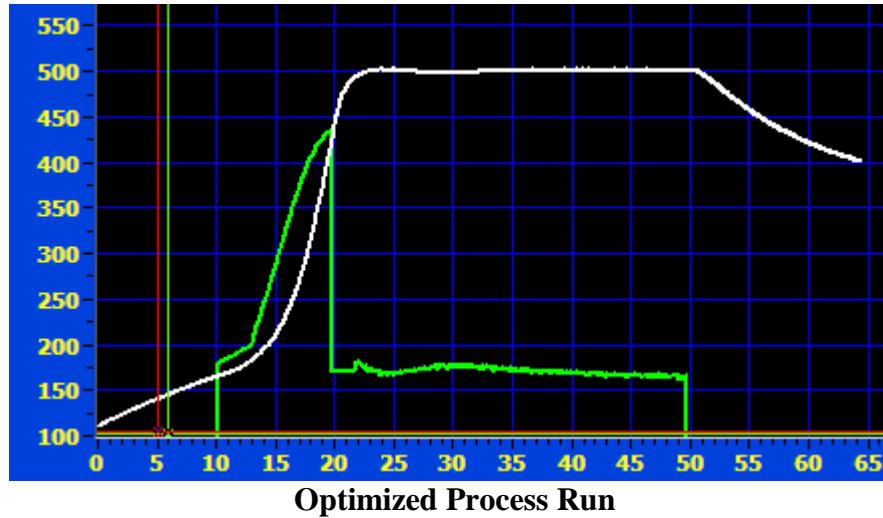

## 6.8F Run Page Graphs

The Solaris S/W allows multiple signals to appear on the Run Page graph. These values are toggled on or off in the Administration Page with the Password SSI123. Various combinations of output signals will appear once the Start Button is pressed. The different graphing signals include TrayTC Temp, Thermocouple2 Temp, Lamp Power Level and MFC Total Flow. Attention must be paid to the Y axis values for the Lamp Power and MFC Total Flow. For the Lamp power, 0-1000 degrees, represents 0-100%. For MFC Flow, 0-1000 degrees represents 0-10 SLM.

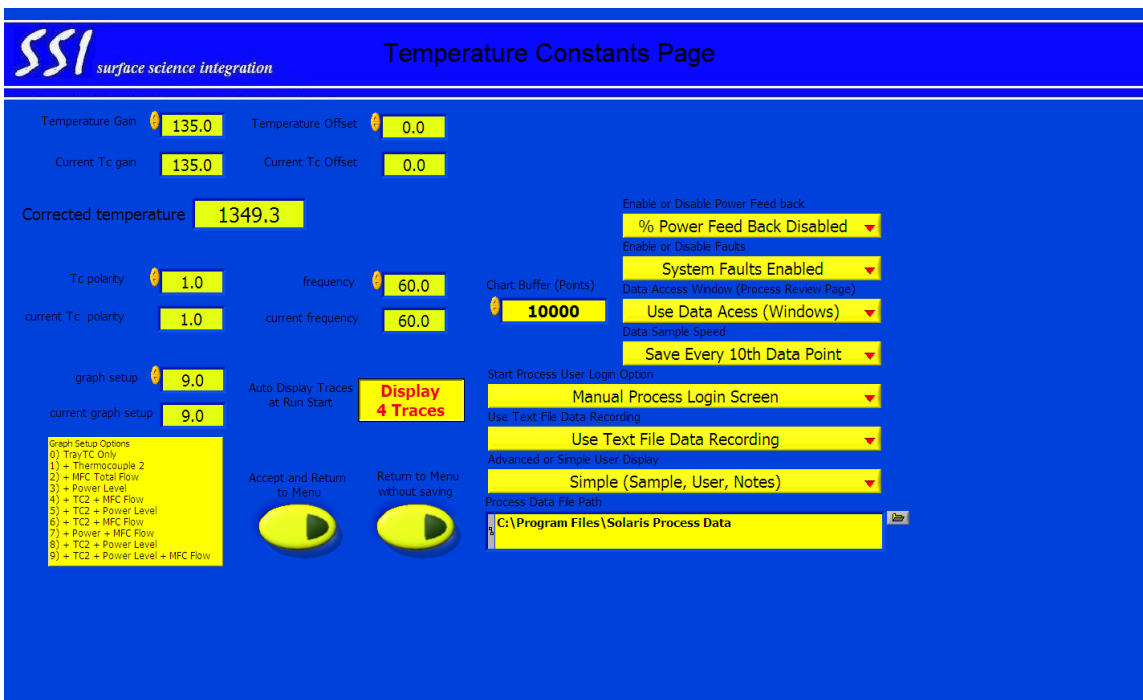

To turn on or off the graphing function, choose a number in the Graph Setup that corresponds to the variables in which you would like to have displayed. To turn on all graphing functions press the **Display 4 Traces** button.

## 6.8D Saving Process Data

The Solaris has several options for storing process run data, which is accessed in the Administration Page by entering the Password SSI123. On the right hand side you will see four pull down menus: **Data Sample Speed, Start Process User Login Screen, Text File Data Recording and Advanced user display.**

The **Data Sample Speed** parameter is used to specify the number of data points that will be stored in a process run. The settings are Every Data Point, Every Second, Forth, Eight or Tenth Data Point. For long process runs, the amount of data that is stored could exceed  $1 \times 10^5$  which is more data than most spreadsheets are able to process. By limiting the amount of data that is taken, the stored data file size will be greatly reduced.

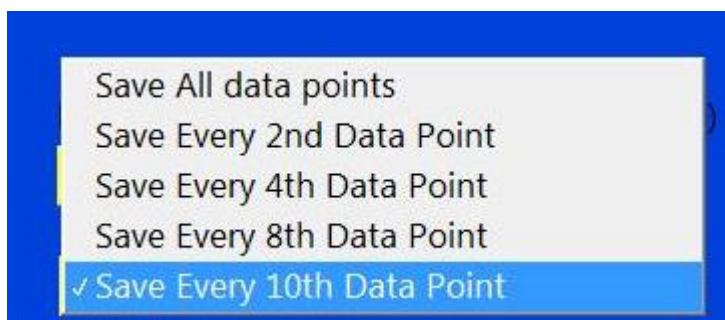

The **Start Process User Login** Screen is used if you wish to have a login screen for each wafer that is processed. The choices are Manual Data Save, Invisible Process Login or Manual Process Login. The manual data save option will signal the S/W to prompt the user with a pop-up screen after a recipe is completed to name the stored file. The Invisible Process Login will automatically save the User name and sample ID to the stored data file and the stored file name will be generated by the Solaris S/W with a time/date stamp and a temperature. The Manual Process Login Screen prompts the user in the Run page to enter a User ID and Sample ID before processing begins.

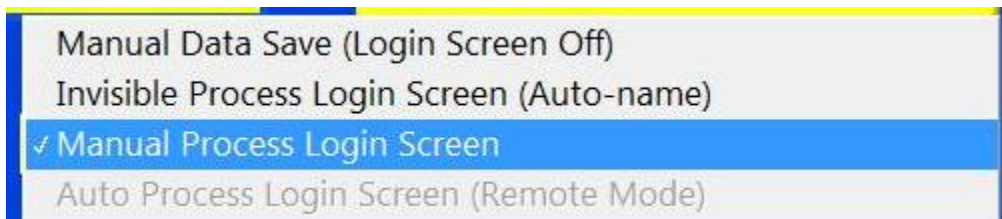

The **Advanced user display** is used in conjunction with the Process Login Screen in which the user is also able to add notes to the saved Data File. In addition a time and date stamp and the recipe name will be displayed in the pop-up Login Screen of the Run page.

The **Text File Data Recording** is an option of generating a simple data file that has simple rows and columns of the process run(old file data recording) or a more complex data file(Text File Data Recording) that lists the recipe, the calibration file used, time/date and max temperature. An example of the Text File Data Recording is shown in the following table:

Step#	Opr T	Cntl T	RR&ST	MFC 1	MFC 2	MFC 3	MFC 4	REM/IN	TCtype	P val	I val	D val	URLP	UFLP	LLP
0.00	0.00	0.00	0.00	0.00	0.00	0.00	0.00	0.00	0.00	0.00	0.00	0.00	0.00	0.00	0.00
1.00	0.00	0.00	10.00	10.00	0.00	0.00	0.00	0.00	0.00	0.00	0.00	0.00	100.00	100.00	100.00
2.00	1.00	400.00	50.00	10.00	0.00	0.00	0.00	85.00	0.00	0.00	0.00	0.00	100.00	100.00	100.00
3.00	2.00	400.00	30.00	10.00	0.00	0.00	0.00	15.00	0.00	-40.00	40.00	0.00	100.00	100.00	100.00
4.00	3.00	300.00	200.00	10.00	0.00	0.00	0.00	0.00	0.00	0.00	0.00	0.00	100.00	100.00	100.00
5.00	4.00	300.00	0.00	10.00	0.00	0.00	0.00	0.00	0.00	0.00	0.00	0.00	100.00	100.00	100.00
* * * * *															
Process Data*															
Time	Temp 1	Temp 2	Power	Flow											
0.10	198.50	1349.34	0.00	296.63	1.00	0.00	0.00	0.00	0.00	0.00	0.00	0.00	0.00	0.00	0.00
0.20	198.33	1349.34	0.00	307.37	1.00	0.00	0.00	0.00	0.00	0.00	0.00	0.00	0.00	0.00	0.00
0.30	198.33	1349.34	0.00	350.83	1.00	0.00	0.00	0.00	0.00	0.00	0.00	0.00	0.00	0.00	0.00
0.40	197.84	1349.34	0.00	489.75	1.00	0.00	0.00	0.00	0.00	0.00	0.00	0.00	0.00	0.00	0.00
0.50	198.08	1349.34	0.00	558.72	1.00	0.00	0.00	0.00	0.00	0.00	0.00	0.00	0.00	0.00	0.00

Bill\*  
Sample B\*  
SOI Test\*  
400 degree 30 sec 100mm Si.txt\*  
07:23:18 PM 05/Mon 04/2009\*  
Peak Temp = 400 C Peak Time = 30 Sec\*  
factory cal.txt\*  
406.14\*

Recipe\*

Process Data\*

## 6.9 Open Loop Processing

The Solaris software allows a saved recipe profile to be processed over and over with the same process conditions and without controlling to the thermocouple. When an optimized process is saved as an OLP (Open Loop Process), the user can use the Run Open Loop screen to process the next set of wafers exactly the same. The software records MFC gas flows and power settings in a usual process and ‘plays’ back the settings at a millisecond rate. Although the Temperature is displayed in Open Loop mode, the software is not controlling to it.

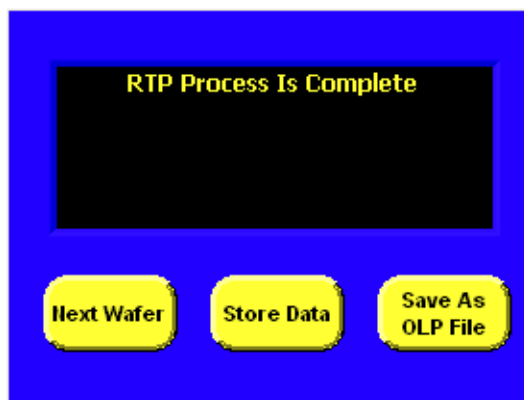

Note: It is advisable to change the data collection to ‘Save All Data Points’ when using the Open Loop Processing. See Section 6.8D.

Once the Save As OLP file icon is clicked, the s/w will prompt the user to name the Open Loop Process Recipe. It is advisable to name the file similar to the original process run. The Open Loop Files cannot be edited and they will not be displayed in the Run Process screens.

To ensure each wafer sees the same process conditions, it is important that each wafer has the same starting temperature. For long processes, in which the chamber warms extensively it may be necessary to place a long purge or a low temperature anneal (100-150 degrees) such that the starting point of each wafer will be the same. To process an Open Loop Recipe, use the pull down menu in the upper right hand corner of the Open Loop process page. The software will display the original process recipe in which the Open Loop recipe was created. Press Start to begin the process.

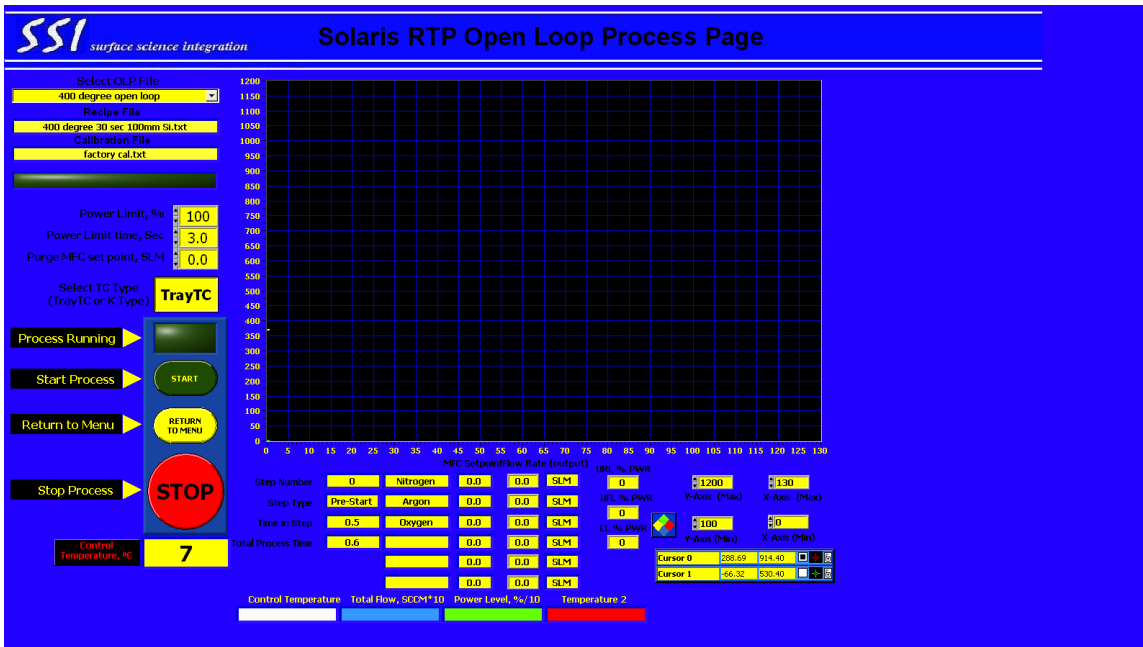

Open Loop Process Page

## 6.10 Tray TC Process Thermocouple Calibration

The SOLARIS software allows the user to create calibration curves for various wafer types and emissivities. The stored calibration curves are assigned to a recipe at the **Recipe Run Page** to compensate for changes in backside emissivity and TC errors.

In general the TrayTC will be corroborated to NIST standards prior to shipment. The TrayTC will stay within calibration for over 1000 wafer cycles, depending on process temperature and times. If the user notices erratic behavior of the TrayTC or if the TrayTC does not stabilize during steady state it may need replaced. This is noticeable by jumps or spikes in the temperature readings.

A quick and easy test to determine if the TrayTC is accurate is to install the supplied TC calibration wafer and run a simple 1000 degree anneal for 60 seconds. Change the control to K-type in the middle of the steady state and confirm that both TC readings are the same or close. You should not see a jump or spike in control readings.

In general the TrayTC should not need a new calibration file unless the TC amplifiers are changed. However to reduce errors with films that have an emissivity that is significantly different from a uncoated silicon wafer, the Solaris SW can compensate by employing calibration files for each wafer type.

The SOLARIS software compares the Tray TC Process TC signal to a standard thermocouple temperature reading over a user defined recipe to create essentially a temperature error curve. This curve is used when running a recipe to compensate for TrayTC Process TC signal errors generated by changes in emissivity and heat exchange

errors over the temperature range. The user is able to define calibration curves for individual recipes.

To run a calibration the user needs a thermocouple instrumented wafer. The TC wafer can rest on top of the product wafer.

**Note: For best accuracy it is advisable to attach a TC to a wafer that is similar to the Product Wafer.**

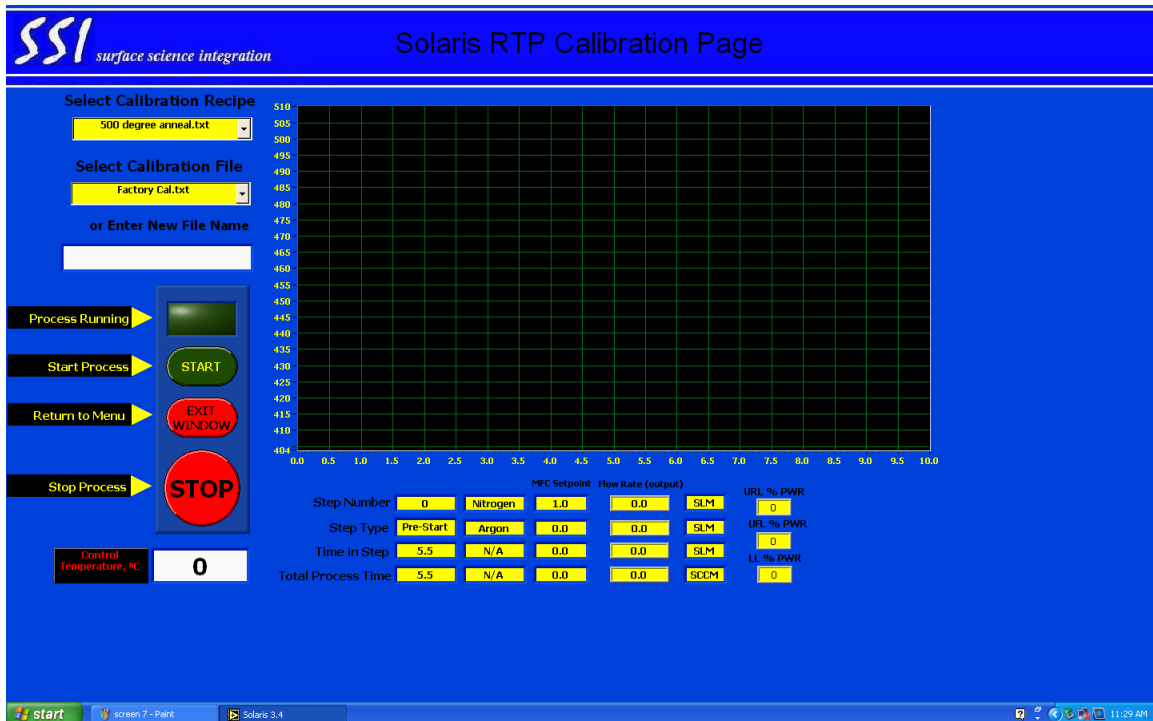

The process recipe to be calibrated in entered using the pull down menu box.

The calibration name is entered in the **File Name** box. It is convenient to use a similar name as the process recipe. For instance if recipe name is “Titanium Anneal” the calibration name would be “Titanium Anneal Cal” The **Abort Temperature** is set at 1200 °C in order to avoid damaging the calibration wafer or thermocouple. Once the calibration curve has been created, the user will be able to attach the calibration curve to a recipe in the **Recipe Editor Page**.



## SECTION 7

### SYSTEMS DIAGNOSTICS and CONFIGURATIONS

The Systems Check Page is used to monitor the tool performance and create temperature calibrations. The different options include:

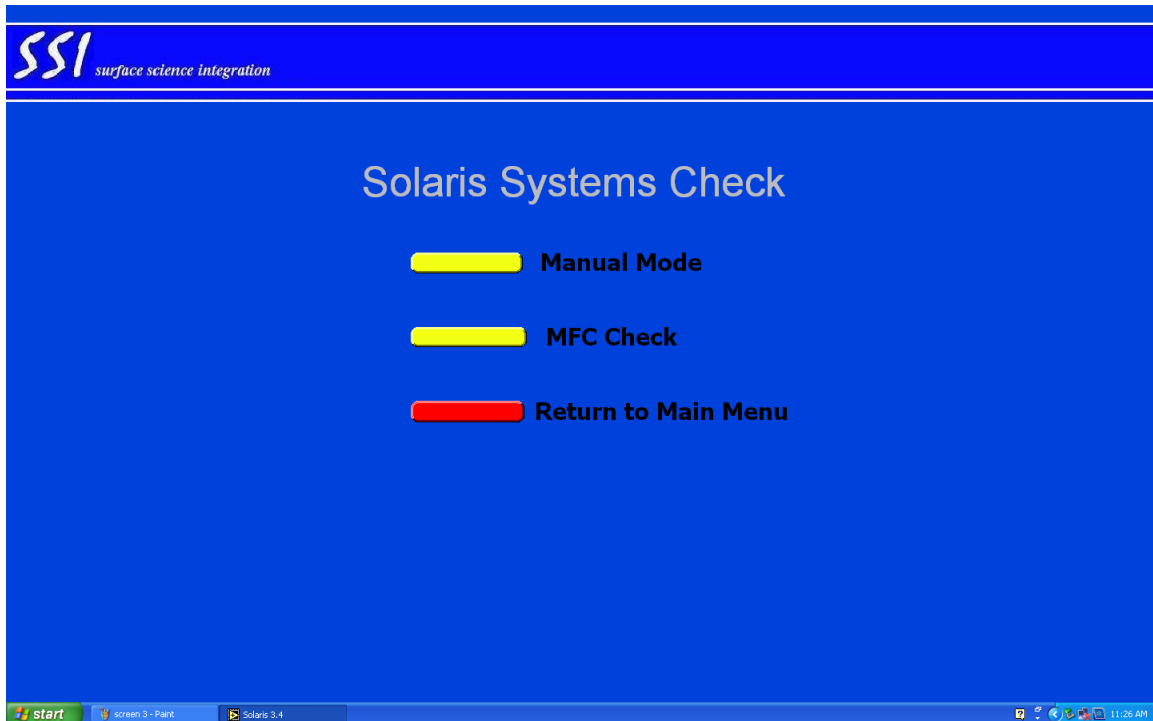

**Manual Mode:** Used to test the functionality of the lamps and communication by sending a computer generated pulse manually.

**MFC Check:** This page is used to input a specific MFC flow rate and monitor the voltage output to determine flowrate accuracy and to check communication between the MFCs and controller. If the Solaris does not have installed MFCs and is running with a rotometer this page will not be active.

## 7.1 Communication Check

This menu allows the user to manually turn on and off the lamps and check the communication between the controller and the oven. The manual lamp driver sends a signal to the lamps based on a 0-10 volt signal.

To activate the lamp driver use the thermometer slider to send a voltage value. **Press start.** Then press **Begin Testing.** If the lamps are activated the communication between the controller and oven is functioning correctly. If the lamps do not activate there is a problem. Note: the manual lamp driver has a time out after 20 seconds or if the oven temperature exceeds 900°C. Note: All Interlocks are defeated, care must be taken when running in manual mode.

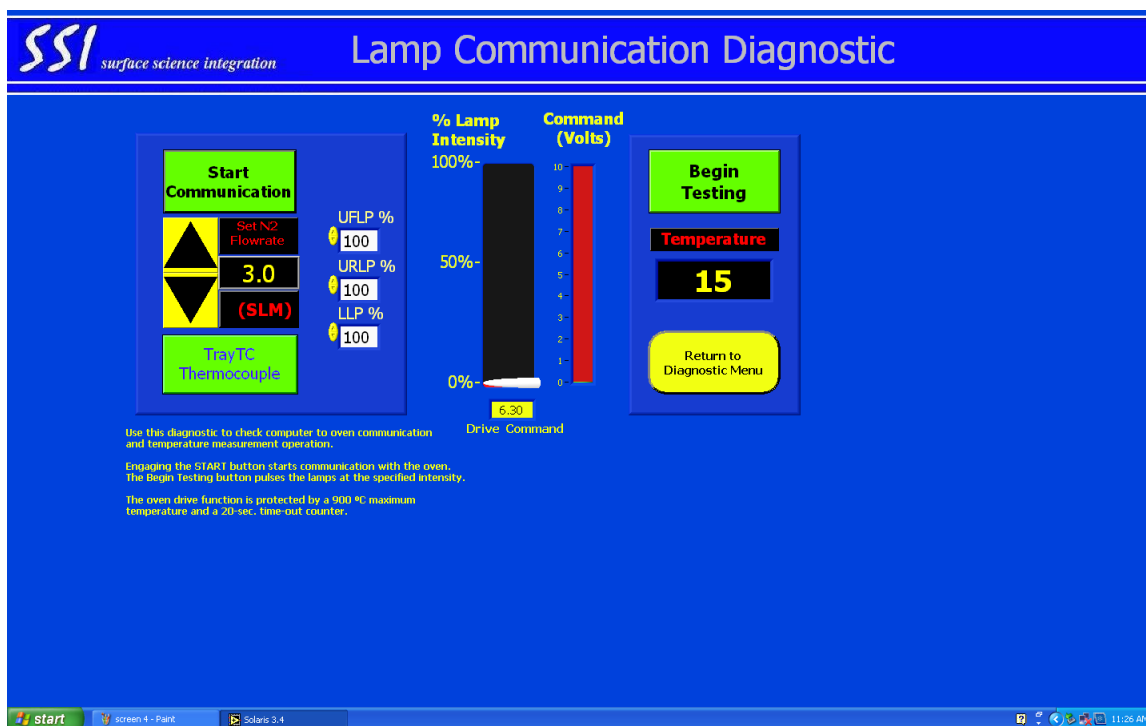

For troubleshooting, to check individual lamp zones set the other two lamp power percentages to zero.

## 7.2 MFC Checkout

The MFC check page allows the user to manually turn on the MFCs without creating and processing a recipe. The MFC checkout procedure will monitor the designated flow rate of the MFCs and monitor the feedback to the controller to ensure communication to and from the MFC and the functionality of the MFCs. To start the checkout procedure, simply increase the flow rate of the MFC to a desired value, the MFC output box should read the same value. Note there is a slight delay in the MFC response before reaching setpoint.

Gas Type	Flow Rate	Output
Nitrogen	0.0	0.0 SLM
Argon	0.0	0.0 SLM
N/A	0.0	0.0 SLM
N/A	0.0	0.0 SCCM

Stop and Return to Menu

### 7.3 Administration Options

The Administration Options page is for the initial setup of the SOLARIS software. The choices available within the Administration page include used to setup passwords, delete files and initially set the configuration of the onboard MFCs. The Administration page can be password protected. Surface Science Integration recommends changing the initial password once the Administration page is accessed.

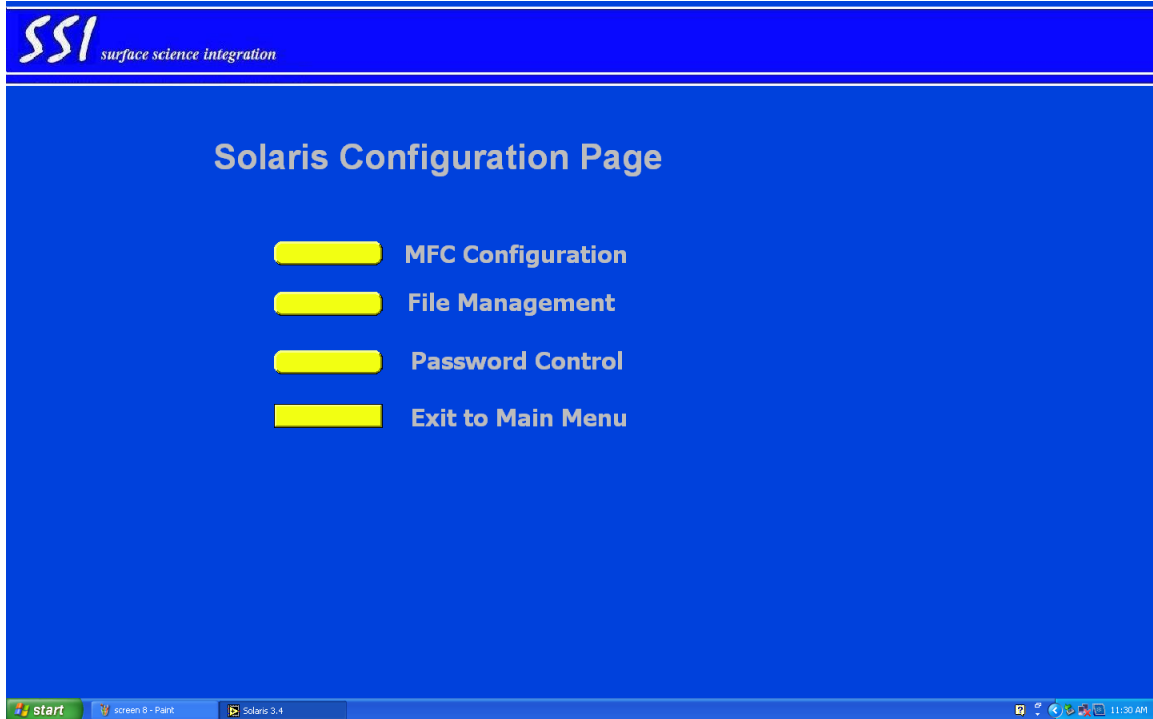

## 7.4 MFC Configuration Page

The MFC Definition page is used to input the gas flow type and maximum flow rate of the MFCs in use. The maximum flow rate is labeled on the MFC and is inputted directly or with the pull down menu. The type designates whether the MFC flow rate is in SLM or SCCM. Although the total size of the MFCs can be of most any value, the maximum total flow through the Solaris is limited to 10 SLM.

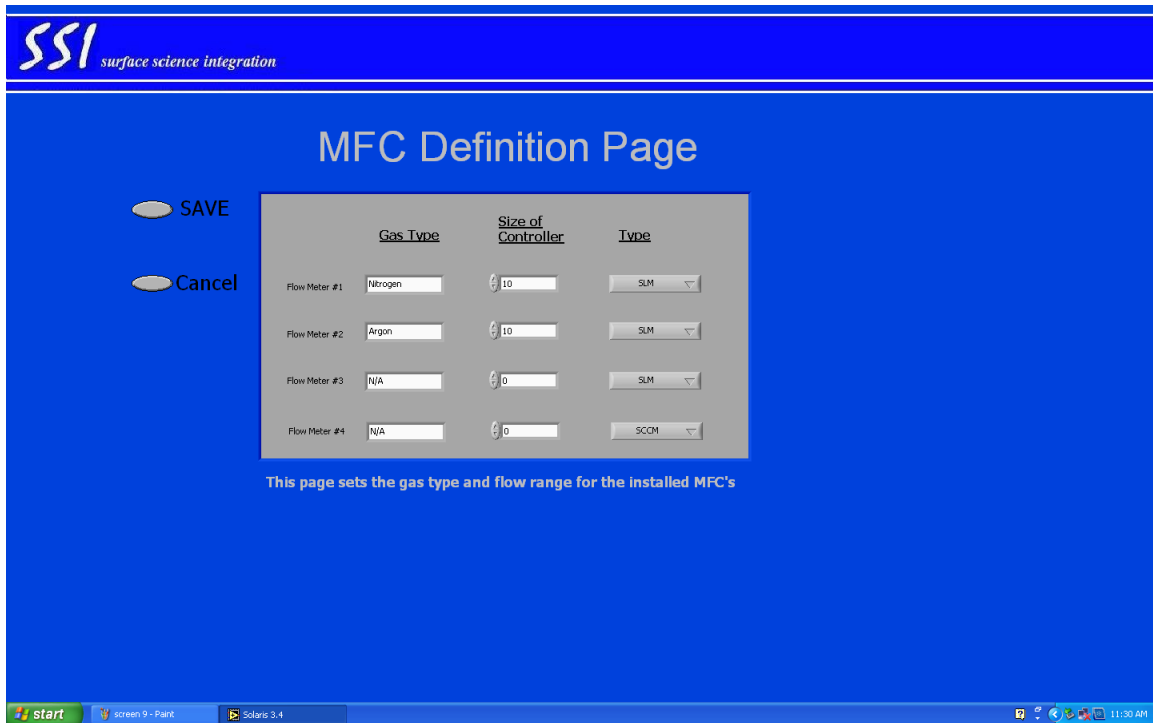

The Solaris software is interlocked such that the user cannot intentionally input a flow rate greater than 10 SLM unless the MFC size or type is not inputted correctly.

## 7.4a New MFC Configuration Page

Some Solaris systems are configured with a gain and offset control for running alternative gases as to which the MFC is calibrated for. Similar to the older MFC configuration page, the user inputs the MFC gas and size in SLM or SCCM. The new page has the option of inputting gains and offsets such that the MFC will flow correctly for alternative gases. General lookup tables for gas conversion factors can be obtained from general vendors such as Air Products or MKS allow the determination of the correct variables.

Flow Meter #	Gas Type	Input		Output		Size of Controller	Flow Units
		Offset	Gain	Offset	Gain		
Flow Meter #1	Nitrogen	0.000000	1.000000	0.000000	1.000000	10	SLM
Flow Meter #2	Argon	0.000000	1.000000	0.000000	1.000000	10	SLM
Flow Meter #3	Oxygen	0.000000	1.000000	0.000000	1.000000	10	SLM
Flow Meter #4		0.000000	0.000000	0.000000	0.000000	0	SLM
Flow Meter #5		0.000000	0.000000	0.000000	0.000000	0	SLM
Flow Meter #6		0.000000	0.000000	0.000000	0.000000	0	SLM

SAVE CANCEL

This page sets the gas type, offset, gain and flow range for the installed MFC's

*New MFC Configuration Page*

## 7.5 Password Control

In the **Password Control** page the user can input up to six different passwords. The recipe edit and creation page and the **Administration** page are password protected. To input a password enter the designated password name(s) and click the **Store and Exit** icon.

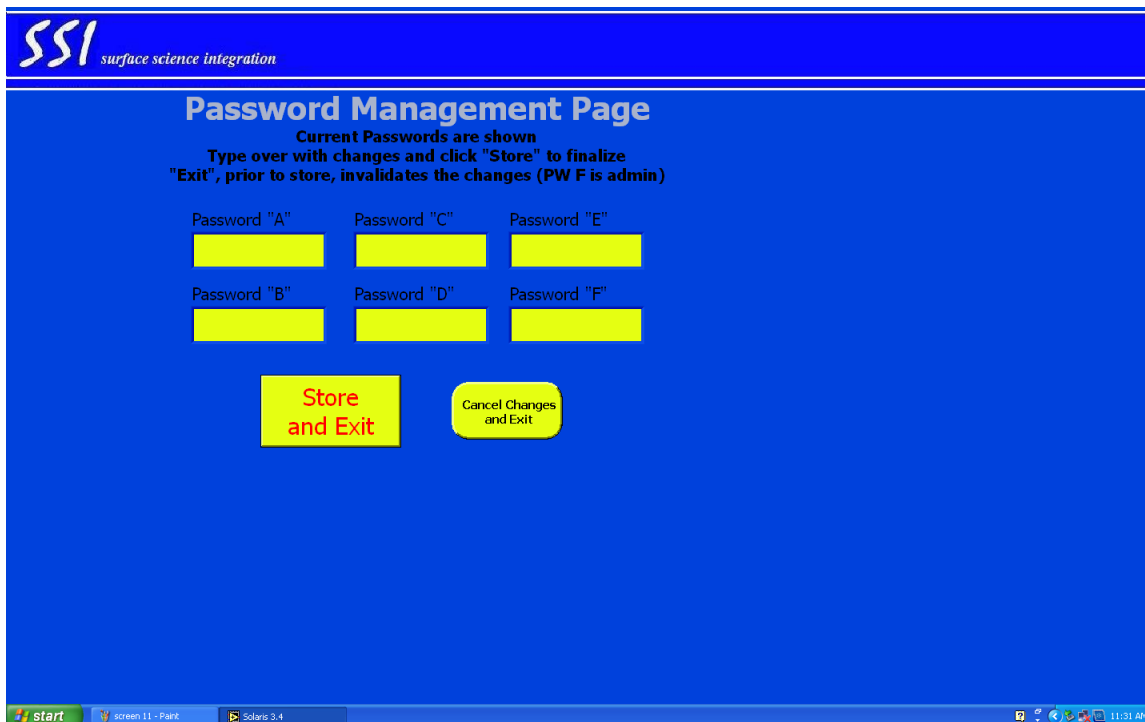

The screenshot shows the 'Password Management Page' from the SSI (Surface Science Integration) software. The page has a blue header with the SSI logo and the text 'surface science integration'. Below the header, the title 'Password Management Page' is displayed in white. Underneath the title, there are instructions: 'Current Passwords are shown', 'Type over with changes and click "Store" to finalize "Exit", prior to store, invalidates the changes (PW F is admin)'. The page contains six password input fields arranged in two rows of three. The first row contains 'Password "A"', 'Password "C"', and 'Password "E"'. The second row contains 'Password "B"', 'Password "D"', and 'Password "F"'. Each field is currently empty. At the bottom of the page, there are two buttons: a red button labeled 'Store and Exit' and a yellow button labeled 'Cancel Changes and Exit'. The Windows taskbar is visible at the bottom of the screenshot, showing the start button, open applications (screen.11 - Paint, Solaris 3.4), and system tray icons (time: 11:31 AM).

## 7.6 Engineering Level Constants Page

To access the Engineering level Constants Page, at the Administration type the Password SSI123. The Constants Page is the defining values used by your Solaris to operate correctly. In this page you will find the values of setting up the system for 50/60 Hz, TC gain and polarity and also graphing features.

The screenshot shows the 'Temperature Constants Page' in the SSI software. The page is titled 'Temperature Constants Page' and features the SSI logo. The main content area is blue and contains several input fields and dropdown menus. The 'Temperature Gain' is set to 135.0, 'Temperature Offset' to 0.0, 'Current Tc gain' to 135.0, and 'Current Tc Offset' to 0.0. The 'Corrected temperature' is displayed as 1349.3. The 'Tc polarity' is set to 1.0, and 'frequency' is set to 60.0. The 'current Tc polarity' is also 1.0, and 'current frequency' is 60.0. The 'Chart Buffer (Points)' is set to 10000. There are several dropdown menus for 'Enable or Disable Power Feed back' (set to '% Power Feed Back Disabled'), 'Enable or Disable Faults' (set to 'System Faults Enabled'), 'Data Access Window (Process Review Page)' (set to 'Use Data Access (Windows)'), 'Data Sample Speed' (set to 'Save Every 10th Data Point'), 'Start Process User Login Option' (set to 'Manual Process Login Screen'), 'Use Text File Data Recording' (set to 'Use Text File Data Recording'), and 'Advanced or Simple User Display' (set to 'Simple (Sample, User, Notes)'). The 'Process Data File Path' is set to 'C:\Program Files\Solaris Process Data'. There are also two buttons: 'Accept and Return to Menu' and 'Return to Menu without saving'. A 'Graph Setup Options' list is visible on the left side of the page.

The Temperature gain should be a fixed value at 135. This value represents the degrees per millivolt of signal measured from the wafer. In general 0-10 volts is equivalent to 0-1350 degrees.

The TC polarity should always be set at 1.0, this box can be used to change the polarity of the thermocouple if they are installed backwards. It is not recommended to change the polarity within the software, rather change the TC wires inside the Solaris oven.

The graph setup box is used to graph various parameters on the Run Page. If needed, the user can graph the K-Type TC, MFC Total Flow Rate and Lamp Power Levels. The represented values by the MFC Total flow on the Run page graph is 0-1000 degrees which corresponds to 0-10 SLM. In addition the Power level of 0-100% is indicated by 0-1000 degrees.



## Advanced Processing Techniques

For the **Engineering level Constants Page** there are several features that allow the user to test or control the Solaris that are beyond what the general user would require.

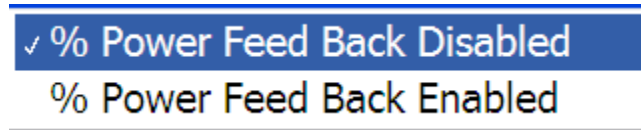

The % Power Feedback pull down menu allows the user to automatically feedback to the recipe the % power calculated with each process run. In other words the % Power Feedback acts similar to the LEARN mode algorithm except the REM value is not fed back to the recipe. The % Power Feedback is applicable when slight changes in Temp are made to a recipe and the user requires recipe storage.

The **System Faults** pull down menu allows the user to turn off all interlocks. The user should take care when disabling the interlocks tool damage could occur in an Overtemp or overheat condition. This parameter should only be used in troubleshooting machine faults.

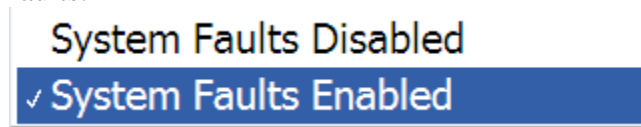

## 7.7 Recall Data Screen

The Solaris s/w allows the user to recall old data on a graphical level. The data must be saved after a process run in order to be recalled. Also data can only be recalled if it visible at the time of the process run. In other words, in order to view old power or MFC data, the graphing function for these variables must be turned on in the Temperature Constants page.

To recall old data you will need to set the data display path. Click on the Data Path Icon

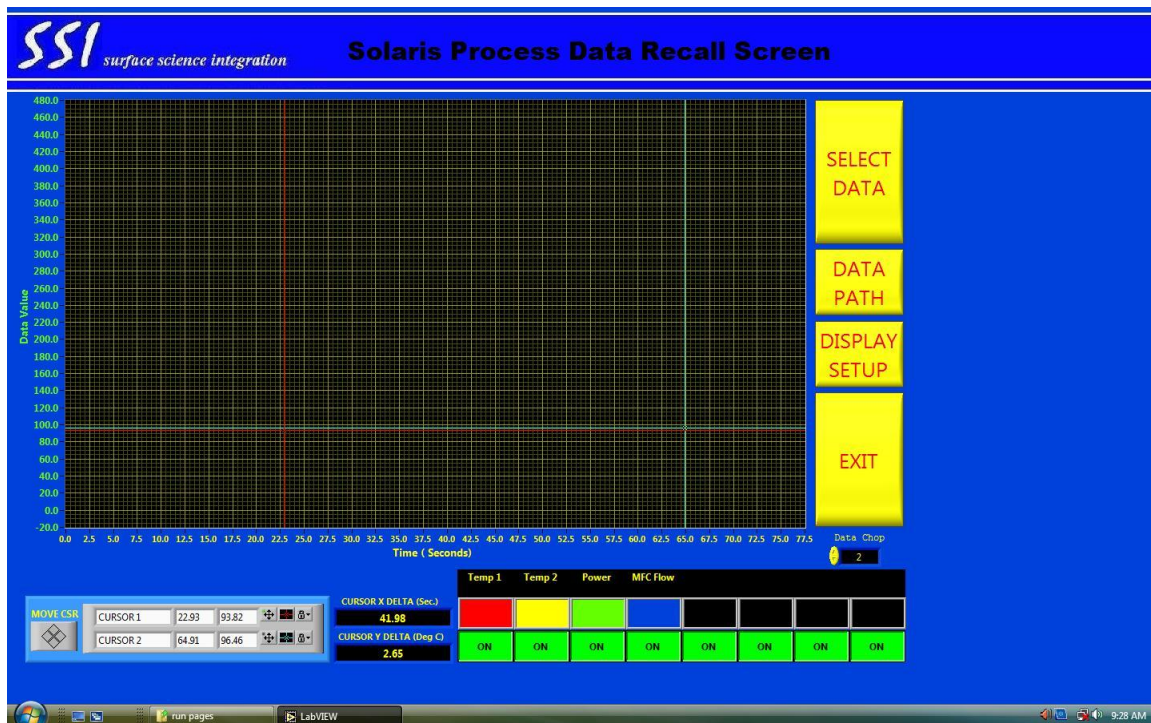

*Solaris Process Data Recall Screen*

Choose in which directory the process data is located. Click the Select Directory Icon in the Windows pop-up menu. Next, click the Select Data Icon to view previously saved data.

The user is also able to change colors and display names by using the Display setup selection. The top half of the selection box is used for colors and the bottom half is used for variable names. The recall data screen is useful for finding faults within a process. For instance the next screen displays a fault that occurred when a gas bottle was turned off prior to processing wafers. The recalled data simply shows the total MFC flow was 1.0 SLM instead of the programmed 10 SLM flow rate.



*Solaris Process Data Recall Screen Displaying Faults*

## SECTION 8

# TROUBLESHOOTING GUIDE

This guide is intended to help you fix some of the common problems that may occur during installation. If you need further help, contact [Surface Science Integration](#) Customer Support. Telephone numbers are listed in the front of this manual. More details on returning parts and contacting [Surface Science Integration](#) for assistance are listed in [Appendix C](#).

### **WARNING !**

**For your safety, all power must be OFF at the power distribution panel before performing any diagnostic or service procedures inside the system.**

#### **8.1 Gas Leak Check Failure**

If the system is not leak tight, perform the following:

1. Check all of the O-rings for proper placement.
2. Tighten the purge inlet and outlet connectors.
3. Ensure that the door is closed and locked.
4. Check the quartz tube flange for polished smoothness. There should be no cracks or rough surfaces.
5. Check to ensure that the screws are tight on the flange. Tighten all screws evenly in a star pattern a little at a time.

#### **8.2 Computer Problems**

##### **Cannot Access any Screens Beyond the Logo Screen**

1. Ensure that all SOLARIS S/W cards are configured correctly.
2. Make sure that the cards are plugged in all the way.

##### **Will Not Execute a Recipe**

1. Check the cables between the computer and the PC Controller and between the PC Controller and the oven to ensure that they are connected.
2. Make sure the heating chamber is turned ON.
3. Make sure the Lamp Control Switch on the system is set to **AUTO**.

#### **8.3 Heating Chamber Problems**

Troubleshooting steps for heating chamber problems are described below.

##### **Green Power Light Not On**

1. Check to make sure the power is ON at the circuit breaker.
2. Check the power switch to make sure it is ON.
3. Check the fuses on the back panel.

##### **Green Light OFF, Red Overheat Light ON**

1. This indicates that the oven walls have overheated. Check the incoming water

supply to ensure you have the two (2) gallon per minute minimum flow  
2. Check the wires on the thermostats on the bottom of the oven to make sure that they are secure.

**No Display On LED Readout**

1. Make sure that the computer is turned ON since it supplies power (5-volts) for the LED Readout.
2. Check the cables between the computer and the PC Controller and between the PC Controller and the oven to ensure that they are connected properly.
2. Check to make sure the heating chamber is turned ON.

**Lamps Will Not Turn ON in Automatic Mode**

1. Oven cooling water turned OFF or low flow. Water flow must be greater than 1.6 GPM.
2. Loose cable connectors to PC boards inside oven cabinet.
- .3. Verify that the SOLARIS S/W cards are configured properly and are plugged in all the way.

## APPENDIX A

### SYSTEM SPECIFICATIONS

Following are the specifications for the Solaris 150 system.

- **Wafer handling:** Manual loading of wafer into the oven, single wafer processing.
- **Wafer sizes:** 2", 3", 4", 5" and 6" wafers and pieces.
- **Ramp up rate:** 1-200°C per second(dependent on size), user-controllable.
- **Recommended steady state duration:** 0-600 seconds per step.
- **Ramp down rate:** Temperature Dependent, max 150°C per second.
- **Recommended steady state temperature range:** 200°C - 1250°C
- **Thermocouple temperature accuracy:** + 2.5°C
- **Temperature repeatability:** + 3°C or better at 1150°C wafer-to-wafer.  
(Repetition specifications are based on a 100-wafer set.)
- **Temperature uniformity:** + 5°C across a 6" (150 mm) wafer at 1150°C. (This is a one sigma deviation 100 angstrom oxide.)

## APPENDIX B

### SPARE PARTS KITS

One of the easiest ways to help to ensure maximum uptime for your Solaris 150 system is to stock an adequate supply of spare parts on-site. This is especially true if the system is used in production. Surface Science Integration has developed three different spare parts kits, depending upon the level of support that the system requires.

The Level 1. Spare Parts Kit is a consumables spare parts kit and includes items not reusable. These parts are used on a routine basis.

#### *Level 1 Spare Parts Kit*

##### **Part Suggested Quantity**

Lamp (1200 W, 208V) 5  
O-Ring, Kalraz 3/8 x 9/16 x 3/32 2  
O-Ring, Tube-to-Inner Flange 2  
O-Ring, Tube to Outer Flange 4  
Fuse, 1 Amp, 250V, FST-BLO 2  
Fuse, .5 Amp, 250V, FST-BLO 2  
Fuse, 5 Amp, 250V, FST-BLO 2  
Fuse, 90 Amp, 600 V 2  
Strainer, Water Line 2

The Level Two Spare Parts Kit contains all of the items listed in the Level One Spare Parts Kit plus additional spare parts that will allow troubleshooting of most problems. This kit is recommended for most customers to have on-site.

#### *Level 2 Spare Parts Kit*

##### **Part Suggested Quantity**

Lampholder, Tungsten Halogen, 10 Amp, 600V 2  
Water Flow Switch 1  
Switch, Mini, 10A 1  
Switch, SPDT, Interlock, 5A 1  
Valve, Solenoid, N.C., 2-Way 1  
Strainer, Water Line 2  
Thermostat, Overcool "A" 1  
Thermostat, Overcool "B" 1  
Thermostat, Open = 150 F, CL=135F 1  
TC Amplifier Assembly 1  
Lamp (1200 W, 208V) 5  
O-Ring, Kalraz 3/8 x 9/16 x 3/32 2  
O-Ring, Tube-to-Inner Flange 2  
O-Ring, Tube-to-Outer Flange 4  
Fuse, 1 Amp, 250V, FST-BLO 2  
Fuse, .5 Amp, 250V, FST-BLO 2  
Fuse, 5 Amp, 250V, FST-BLO 2

Fuse, Modified 2

Level Three Spare Parts Kit is the ultimate in serviceability. It includes all parts in the Level One and Two Spare Parts Kits plus all other major system modules. This kit allows you to have a great deal of flexibility in maintaining your system. It is highly recommended for any system that is used in a production environment.

### ***Level 3 Spare Parts Kit***

#### **Part Suggested Quantity**

Lampholder Tungsten Halogen, 10 Amp, 600V 2

Flowmeter, Panel-Mounted 1

Valve, Solenoid, NC, 2-Way 1

Thermocouple Feedthrough Fitting Set 1

Water Flow Switch 1

Circuit Breaker, 1-Pole, 1A 1

Contactor, 2-pole, 24VAC, 95A 1

Power Module, AC/DC, Linear 1

SCR, Dual Pair, 90A, 600VAC 2

Switch, Mini, 10A 1

Switch, SPDT, Interlock, 5A 1

Thermostat, Overcool "A" 1

Thermostat, Overcool "B" 1

Thermostat, Open = 150 F, CL=135F 1

Lamp (1200 W, 208V) 5

O-Ring, Kalraz 3/8 x 9/16 x 3/32 2

O-Ring, Tube-to-Outer Flange 4

O-Ring, Tube-to-Inner Flange 2

Fuse, 1 Amp, 250V, FST-BLO 2

Fuse, .5 Amp, 250V, FST-BLO 2

Fuse, 5 Amp, 250V, FST-BLO 2

Fuse, Modified 2

Strainer, Water Line 2



# APPENDIX C

## HOW TO ORDER/RETURN EQUIPMENT

The information contained in this appendix includes the following:

- How to order equipment
- How to return parts
- How to exchange parts
- What to do when the system is down
- Service Agreements

### C.1 How To Order Equipment and Parts

To order parts from Surface Science Integration, call:

**Surface Science Integration  
Customer Support  
(800) 749-7473**

To obtain a quote and information concerning part availability, please have the following information ready:

- System model number (example: Solaris 150)
- Serial number of the system
- Part number of the required part
- Purpose of order (spares, failed part, etc.)
- "Ship To:" address
- "Bill To:" address
- Purchase order number

### C.2 How To Return Parts

**An RMA (Return Material Authorization) number must be obtained from SSI prior to shipping any parts back to Surface Science Integration. RMA numbers may be obtained from SSI Sales Administration.**

Return any failed parts to the following address:

**Surface Science Integration  
8552 N. Dysart Road Suite 200B, El Mirage, AZ 85253  
Attn: Customer Support**

Include the information below with the part:

- System model number (example: Solaris 150)
- Part number of failed part
- Reason for failure
- Serial number of system
- "Ship To:" address
- "Bill To:" address
- Purchase order number

- RMA (Return Material Authorization) number

As the customer, it is your responsibility to return the part in its proper packing container. Failure to return the part properly could result in further damage to the part.

**The RMA (Return Material Authorization) number must be visible on the outside of the package when returning a failed part. SSI will not accept returned parts without an RMA number. This could result in the sender being billed for the full purchase price.**

### **C.3 How To Exchange Parts**

After troubleshooting to isolate a failed part, replace the part with a site spare if one is available. If the system is down due to an isolated failed part and no site spare is available, call:

**Surface Science Integration  
Customer Support  
(800)749-7473**

Contact [Surface Science Integration](#) Customer Support to properly identify the failed part. Surface Science Integration will issue an RMA (Return Material Authorization) number to you, which must be included when the failed part is returned. The failed part *MUST* be returned to Surface Science Integration within ten (10) days in the proper packing container or the full purchase price will be billed. Replacement parts under warranty are shipped out in the most timely manner possible.

All returned parts must be shipped in the same packing material as the replacement part. Failure to return the part in the proper packing container could result in further damage to the part.

### **C.4 What To Do When The System Is Down**

If the system is down and you cannot isolate or fix the problem within a reasonable period of time, call Surface Science Integration Customer Support for telephone assistance or a service visit. Toll-free telephone numbers are staffed by trained Surface Science Integration technicians who can provide on-the-spot help with difficult problems and advice on repairs.

**(800)749-7473  
FAX: (800)749-7473**

### **C.5 Maintenance Plans**

#### **Extended Maintenance Plans**

Surface Science Integration's commitment to customer support carries on past the warranty period. By offering a choice of extended maintenance plans, we can satisfy most of your service requirements. Contact Surface Science Integration Customer Support Sales Administration for more details.

#### **Service Training**

Solaris system uptime may be increased dramatically by having trained inhouse personnel and spare parts kits. Operator's training (a one-day course) and

Service training (a two-day course) are available at Surface Science Integration for a fee. These courses cover the following types of information:

- System overview
- Operation
- Software use
- Recipe construction
- Temperature control and optimization
- Preventive maintenance
- Electronics operation and troubleshooting
- Temperature monitoring using the thermocouple and Tray TC

Students are usually Applications Specialists, Equipment Engineers, System Operators and Maintenance Technicians. Emphasis is on hands-on work, as the classes are small and allow personalized instruction.